

**U.S. DEPARTMENT OF COMMERCE
NATIONAL OCEANIC AND
ATMOSPHERIC ADMINISTRATION
NATIONAL MARINE FISHERIES SERVICE
SILVER SPRING, MARYLAND**

**ENVIRONMENTAL ASSESSMENT
OF
BLACK BAYOU HYDROLOGIC RESTORATION
CWPPRA PROJECT CS-27**

CAMERON PARISH, LOUISIANA

NOVEMBER 2000

**U.S. DEPARTMENT OF COMMERCE
NATIONAL OCEANIC AND
ATMOSPHERIC ADMINISTRATION
NATIONAL MARINE FISHERIES SERVICE
SILVER SPRING, MARYLAND**

**ENVIRONMENTAL ASSESSMENT
OF
BLACK BAYOU HYDROLOGIC
RESTORATION**

CWPPRA PROJECT CS-27

CAMERON PARISH, LOUISIANA

NOVEMBER 2000

PREPARED BY

**GOTECH, INC.
8383 BLUEBONNET BOULEVARD
BATON ROUGE, LOUISIANA 70810
(225) 766-5358**

TABLE OF CONTENTS

Environmental Assessment of Black Bayou Hydrologic Restoration

<u>Section</u>	<u>Page No.</u>
1.0 INTRODUCTION	1
1.1 Project Location	1
1.2 Project Funding	1
1.3 Technical Background	1
1.3.1 Wetland Loss Rates	2
1.3.2 Habitat Diversity	2
1.3.3 Current Conditions	3
1.4 Preliminary Performance and Cost Analysis	4
1.5 Authorization	4
2.0 PURPOSE AND NEED FOR ACTION	5
2.1 Purpose	5
2.2 Need for Action	5
2.2.1 Protection of Existing Wetlands	5
2.2.2 Protection of Wildlife Habitat	5
2.2.3 Protection of Fisheries Habitat	6
2.2.4 Protection of Infrastructure	6
3.0 ALTERNATIVES INCLUDING PROPOSED ACTION	6
3.1 No-Action Alternative	7
3.2 Alternatives Considered	7
3.3 Hydraulic Modeling	8
3.4 Preferred Alternative	9
3.4.1 Site Alternatives	10
3.4.2 Construction Alternatives	11
4.0 AFFECTED ENVIRONMENT	11
4.1 Physical Environment	12
4.1.1 Geology, Soils and Topography	12
4.1.2 Climate and Weather	13
4.1.3 Air Quality	13
4.1.4 Surface Water Resources	13
4.2 Biological Environment	15
4.2.1 Vegetative Communities	15
4.2.2 Essential Fish Habitat	16
4.2.3 Fishery Resources	16
4.2.4 Wildlife Resources	17

4.2.5	Threatened and Endangered Species	18
4.3	Cultural Environment	19
4.3.1	Historical or Archaeological Resources	19
4.3.2	Economics (Employment and Income)	19
4.3.3	Land Use	20
4.3.4	Recreation	21
4.3.5	Noise	21
4.3.6	Infrastructure	21
5.0	ENVIRONMENTAL CONSEQUENCES	21
5.1	Physical Environment	22
5.1.1	Geology, Soils and Topography	22
5.1.2	Climate and Weather	22
5.1.3	Air Quality	22
5.1.4	Surface Water Resources	22
5.2	Biological Environment	22
5.2.1	Vegetative Communities	22
5.2.2	Essential Fish Habitat	23
5.2.3	Fishery Resources	23
5.2.4	Wildlife Resources	23
5.2.5	Threatened and Endangered Species	23
5.3	Cultural Environment	24
5.3.1	Historical or Archaeological Resources	24
5.3.2	Economics (Employment and Income)	24
5.3.3	Land Use	24
5.3.4	Recreation	24
5.3.5	Noise	24
5.3.6	Infrastructure	24
6.0	CONCLUSIONS	24
7.0	PREPARERS	25
8.0	FINDING OF NO SIGNIFICANT IMPACT	25

LIST OF FIGURES

Figure

- 1 Location of Black Bayou Hydrologic Restoration project
- 2 Boundary and construction sites of Black Bayou Hydrologic Restoration project
- 3 Proposed location of rock dike (Site A) on the southern bank of the Gulf Intracoastal Waterway
- 4 Typical cross section and placement of rock dike
- 5 Proposed location of structure in Black Bayou Cutoff Canal (Site B)
- 6 Dimensions and typical cross section of Black Bayou Cutoff Canal structure
- 7 Proposed location of structure in Burton Canal (Site C)
- 8 Dimensions and cross section of Burton Canal structure
- 9 Proposed location of structure in Block's Creek (Site D)
- 10 Dimensions and cross section of Block's Creek structure
- 11 Proposed location of sheet pile structure to replace the collapsed weir (Site E)
- 12 Detail and cross section of location of sheet pile structure
- 13 Cross section of proposed sheet pile weir and proposed plug at the collapsed weir
- 14 Typical cross sections of spoil placement
- 15 Proposed dredging route for access to Site E
- 16 Cross section of dredging route to access Site E
- 17 Schematic of self regulating tide gate at Site E
- 18 Operation of the self regulating tide gate at Site E

LIST OF APPENDICES

Appendix A Literature Cited

**ENVIRONMENTAL ASSESSMENT
OF
BLACK BAYOU HYDROLOGIC RESTORATION
CWPPRA PROJECT CS-27**

Cameron Parish, Louisiana

1.0 INTRODUCTION

This Environmental Assessment (EA) evaluates the impacts of activities to enhance wetlands in the northwestern quadrant of the Calcasieu-Sabine Basin about 5 miles (8 kilometers) southeast of Orange, Texas (Figure 1). The project is called Black Bayou Hydrologic Restoration and is located in northwestern Cameron Parish with a narrow strip in southwestern Calcasieu Parish, Louisiana (Figure 2).

This project is part of the Coastal Wetlands Planning, Protection, and Restoration Act (CWPPRA) of 1990 (16 U.S.C. §§ 777c, 3951-3956). In accordance with CWPPRA, the heads of five Federal agencies and the Government of the State of Louisiana comprise a Task Force to implement a Comprehensive approach to restore and prevent the loss of coastal wetlands in Louisiana (16 U.S.C. § 3952 (b) (2)). The Federal agencies involved are the U.S. Army Corps of Engineers (USACE); the U.S. Department of Commerce, National Oceanic and Atmospheric Administration, National Marine Fisheries Service (NMFS); the U.S. Department of Interior, Fish and Wildlife Service (FWS); the U.S. Department of Agriculture, Natural Resources Conservation Service (NRCS); and the U.S. Environmental Protection Agency (EPA). The Black Bayou Hydrologic Restoration project was on the Sixth Priority Project List Report, approved by the CWPPRA Task Force in April 24, 1997, and will soon be ready for construction.

1.1 Project Location

The Black Bayou Hydrologic Restoration project is located in the extreme southwestern portion of Louisiana (Figure 1) in Cameron and Calcasieu Parishes and consists of 25,530 acres (10,330 hectares). The project area is bordered by the Sabine River on the west, Black Bayou and an oil field shell road and borrow canal on the south, boundary or management levees on the east and the Gulf Intracoastal Waterway (GIWW) on the north (Figure 2). Hackberry, Louisiana, the closest town within the state, is located about 18 miles (29 kilometers) east-southeast of the project area.

1.2 Project Funding

CWPPRA is providing 85 percent of the funding for this project with 15 percent of the cost shared by the State of Louisiana, Department of Natural Resources (LDNR). The project is administered by cooperative agreement between the LDNR and NMFS.

1.3 Technical Background

The Louisiana Coastal Zone contains 7.9 million acres (3.2 million hectares) of which about 3 million acres (1.2 million hectares) are coastal marshes. According to the Louisiana Coastal Wetlands Conservation and Restoration Task Force (1993) using data from the U.S. Geological Survey and the Louisiana Department of Natural Resources 1988/1990 habitat maps, there are 312,500 acres (126,500

hectares) classified as marsh within the Calcasieu-Sabine Basin, 269,000 acres (108,900 hectares) of open water or canals, and 48,500 acres (19,600 hectares) classified as other, i.e., agriculture, pasture, developed, forest, scrub-shrub or spoil for a total of 630,000 acres (255,000 hectares).

Understanding the causes of wetland loss in coastal Louisiana requires a knowledge of how these wetlands were created and maintained before they began to deteriorate. The Mississippi River formed two distinct geomorphic regions of coastal Louisiana over the last 7,000 years - the Deltaic Plain and the Chenier Plain. The Deltaic Plain, located in the central and southeastern portions of the coast, has been described extensively (Fisk, 1944; Gagliano and Van Beek, 1970; Penland et al., 1991). Since the end of the last ice age, the river built wetlands in extensive delta lobes and then gradually abandoned the lobes as they became large enough to become hydraulically inefficient. Abandoned delta lobes slowly subsided, although the wetlands maintained themselves for extended periods. Eventually most wetlands disintegrated as the delta lobe subsided to the point that wetland vegetation drowned. Frequently, the river built wetlands in delta lobes on top of the sunken remains of former delta lobes. This cycle of creation, maintenance, and destruction is called the delta lobe cycle and describes landscape evolution in river deltas large and small around the world (Coleman, 1988).

The Chenier Plain formed from marine transport of westward flowing near-shore currents of mostly fine grained Mississippi River sediments. Depending on the amount of material and the duration of flow, mud flats of various widths and lengths accumulated against the shoreline. When the elevation became high enough to support vegetation, marsh plants colonized the area. When deposition ceased or declined because the Mississippi River shifted its course to the east, these deposits were reworked by coastal processes, concentrating the coarse grained marine sediments, and forming shore-parallel ridges or "cheniers" (Gould and McFarlan, 1959). Ridges often are covered with live oak trees, hence the name Chenier from the French word "chene" for oak.

1.3.1 Wetland Loss Rates

It is not possible to accurately estimate wetland loss rates prior to the 1930's because quantifying the area of ponds and lakes in the marsh and swamp interior requires aerial photographs or satellite imagery which do not exist. Wetland loss rates in coastal Louisiana increased geometrically from the 1930's through the 1960's, but declined in the most recent period of measurement. Although marsh loss rates have declined by almost 50 percent throughout coastal Louisiana since the 1960's, on the average coastal Louisiana still lost 2.5 acres (1 hectare) per day between 1979 and 1990 (Barras et al., 1994). The project area has lost nearly 10,000 acres (4,050 hectares) or 40 percent of its wetlands since 1950.

Corps of Engineers land loss data is unavailable for the Black Bayou area. GIS data indicates dramatic land loss during the period from 1956 to 1978. This land loss has been attributed to hydrological changes, including reduced freshwater inflow from the uplands north of the GIWW, increased magnitude and duration of tidal fluctuations, increased salinities, higher water levels, excessive water exchange, and artificial water circulation patterns. Data from 1984, 1988, and 1990 suggests that there has been an increase in marsh acreage of nearly 2,000 acres (810 hectares). Although some of this gain may be an artifact inherent to the data collection process, several years of abundant rainfall during that period caused the marsh vegetation to thrive. Under drought conditions of the past two years, with the possibility of increased saltwater intrusion to the area, new surveys probably would show either marsh stability or resumption of the loss trends.

1.3.2 Habitat Diversity

Project area habitat includes brackish and intermediate marshes, bayous and open water areas. Because of the various elevations and salinity regimes, vegetative types range from brackish species along the

Sabine River, to upland species on levees and Perry Ridge, with typical transitional, wetland and submerged brackish or intermediate vegetation in the marsh and open water areas.

Wildlife resources in the project area include game and nongame animals and commercially important furbearers and alligators. There is a great variety of birds, including waterfowl which traverse the western side of the Mississippi Flyway.

The intermediate to brackish marshes of the project area provide nursery and forage habitat for numerous recreationally and commercially important estuarine and estuarine-dependent marine finfish, mollusks, and crustaceans. The Sabine River supports a variety of freshwater fishes north of the project area.

1.3.3 Current Conditions

Brackish marsh vegetation covers the western portion of the project area grading into fresh/intermediate marsh in the eastern third. The only fresh marsh is in the northeast corner of the project area.

Marsh soils are subdivided into three salinity classes - fresh, brackish and saline. The intermediate vegetative class reflects the salinity of the soil surface layer, not the salinity of the soil profile. Approximately 70 percent of the intermediate vegetative community in the basin occurs on brackish soils, and the remainder on fresh soils (Louisiana Coastal Wetlands Conservation and Restoration Task Force, 1993a).

The marshes of the project area have been modified or strongly influenced by previously completed Federal projects. A channel (originally the Port Arthur Channel) has been maintained from Sabine Pass to Port Arthur, Texas, since 1899 and later became part of the Sabine-Neches Waterway. This waterway, extending north from the Port Arthur Canal to the west side of Sabine Lake, up the Neches River to Beaumont, Texas, and up the Sabine River to Orange, Texas, was excavated to a 9 foot deep by 100 foot wide (3 by 30 meter) channel in 1908. The Sabine-Neches Waterway now is a 40 foot deep by 500 foot wide (12 x 150 meter) channel from the Gulf to Port Arthur, Texas, a 40 foot deep by 400 foot wide (12 x 120 meter) channel from Port Arthur up the Neches River to Beaumont, Texas, and a 30 foot deep by 200 foot wide (9 by 60 meter) channel from the mouth of the Neches River up the Sabine River to Orange, Texas (U.S. Department of Agriculture, 1994).

The GIWW was completed between the Mississippi and Sabine Rivers by 1925. The section, between the Sabine and Calcasieu Rivers, had been finished in 1915, and was deepened and widened to a channel of 9 feet deep by 100 feet wide (3 x 30 meters). The portion of the GIWW from Sabine River to the Calcasieu River, known as the Lake Charles Deep Water Channel, was enlarged to 30 feet deep by 125 feet wide (9 x 38 meters). Upon completion in 1941 of the Calcasieu Ship Channel, the Lake Charles Deep Water Channel was deauthorized. The GIWW is now maintained at 12 feet deep (3.5 meters). Smaller channels, such as Burton Canal, Black Bayou Cutoff, Vinton Drainage Canal and the numerous canals and slips dredged for access to drill sites in the Black Bayou Oil and Gas Field have destroyed marsh and interrupted water circulation patterns (U.S. Department of Agriculture, 1994).

As of early August 2000, CWPPRA Project XCS-56 was in the planting stage (Paul, Personal communication). This plowed terrace demonstration project (USACE Permit Number WH-19-980-11237) is located in the open water area northeast of the Black Bayou Oil Field and within eastern border of the Black Bayou Hydrologic Restoration project. Approximately 60,000 linear feet (18,000 meters) of terraces 10 feet wide (3 meters) and 3 feet high (1 meter) with 50-foot (15-meter) wide openings every 500 feet (150 meters) have been constructed with a terrace plow implement. Vegetation will be planted at the proper elevation along the water/edge interface.

NRCS has conducted four planting programs in the Black Bayou area (Miller, Personal communication).

Black Bayou Marsh Project - In May 1995, 900 one-gallon sized containers of California bulrush were planted 6 feet (1.8 meters) apart in a single north to south row in the open water area just south of the GIWW and west of Black Bayou Cutoff south of the Calcasieu/Cameron Parish line. At present, the row is not continuous, but overall survival is good with the lateral spread ranging from 10 to 20 feet (3 to 6 meters). Plants appear to be suffering from high salinities.

West Gum Cove Marsh Project - This project also was planted in May, 1995, with the same species, spacing and container size as above but planting 800 containers just west of the Gum Cove Ridge and south of the GIWW on the Calcasieu/Cameron Parish line. Again, the row is not continuous, but overall survival is good with similar lateral spread. These plants also appear to be suffering from high salinities.

Black Bayou Cutoff - In July 1997, 1,150 gallon containers of smooth cordgrass were planted in a single row 5 feet apart along the deteriorated bank of the Old Black Bayou just south of the GIWW. Although survival a year later was approximately 35 percent, the remaining plants have spread to completely revegetate the bayou banks. **Black Bayou Marsh #2** - This project, also in July 1997, used 1,050 gallon-sized containers of California bulrush in a single row 5 feet apart in an area of interior marsh southwest of the Black Bayou Oilfield. Original monitoring showed approximately 70 percent survival, however, that has declined with plants now sporadic and not very dense. Smooth cordgrass, 1,000 gallon-sized containers and 1,000 bare-root plugs was planted across the openings into the marsh on the west side of the Black Bayou Cutoff. Original survival was 85 to 90 percent for the gallon containers and 50 percent for plugs. Although survival has declined, a few scattered clumps are doing well.

1.4 Preliminary Performance and Cost Analysis

Problems and potential solutions in the Black Bayou area were identified by the Task Force during the developmental stages of the Louisiana Coastal Wetlands Restoration Plan (1993b) and further documented in the Calcasieu-Sabine River Basin Study (U.S. Department of Agriculture, 1994), and Coast 2050 (Louisiana Coastal Wetlands Conservation and Restoration Task Force and the Wetlands Conservation and Restoration Authority (1998). A preliminary site inspection was made in August 1993 and the Wetland Value Assessment team visited the area in September 1996. Subsequent to selection by the Task Force on the Sixth Priority Project List, the area has been inspected and pertinent data collected by Project Engineers, and Federal and State sponsor personnel. The first draft of preliminary plans (C.H. Fenstermaker & Associates, Inc., 1999) was completed. Hydraulic modeling, included in the design phase costs, was done by Moffatt & Nichol Engineers (2000), and with the results, several major changes were suggested. On the basis of the hydraulic modeling and a field inspection in early 2000, preliminary plans were revised (C.H. Fenstermaker & Associates, Inc., 2000).

The baseline cost for the Black Bayou Hydrologic Restoration project was \$6,316,800. This project will be maintained and monitored for 20 years.

1.5 Authorization

The NMFS is the federal sponsor for implementation of the Black Bayou Hydrologic Restoration project,

which was included on the Sixth Priority Project List (Louisiana Coastal Wetlands Conservation and Restoration Task Force, 1997). The sponsor's responsibility includes conducting the evaluation and other activities involved for final decision-making in compliance with the National Environmental Policy Act (NEPA) of 1969. To meet NEPA compliance requirements, an EA must be conducted for each wetland project site that is modified or restored.

The project was listed as CS-12 (with some components included in XCS-48) in the CWPPRA Restoration Plan (Louisiana Coastal Wetlands Conservation and Restoration Task Force, 1993a). The original project, now listed as CS-27, has been modified and is included as Strategy number 12 for Region 4 in Coast 2050 (Louisiana Coastal Wetlands Conservation and Restoration Task Force and the Wetlands Conservation and Restoration Authority, 1998).

2.0 PURPOSE AND NEED FOR ACTION

The major goal of CWPPRA is to restore and prevent the loss of coastal wetlands in Louisiana. The Black Bayou Hydrologic Restoration project was proposed and designed to partially meet that goal in an area of Cameron and Calcasieu Parishes and to respond to the need for action as outlined below.

2.1 Purpose

The purposes of the Black Bayou Hydrologic Restoration project are to (1) restore coastal marsh habitat, and (2) slow the conversion of wetlands to shallow open water in the project area.

2.2 Need for Action

There is a critical need to protect and extend the life of emergent coastal wetlands in Louisiana because wetlands rapidly are being converted to open water and wetlands are important to the production of renewable resources. Vegetation types in project area wetlands have transitioned from fresh to brackish. This transition from fresh to more saline was not always successful, resulting in the development of open water areas. Brackish and intermediate marsh systems suffer from the combined impact of limited inputs of both fresh water and sediments. In addition, increased saltwater penetration threatens the optimum growth conditions of brackish vegetation.

2.2.1 Protection of Existing Wetlands

Marsh loss in this region of Louisiana is expected to continue at a similar rate, thereby causing the loss of additional acres of emergent wetlands. The loss of intermediate marsh in the Louisiana coastal zone from 1956 to the present represents a significant natural resource loss. Intertidal marshes are among the most productive ecosystems on earth and their rapid disappearance may significantly impact the economy of South Louisiana. Action is needed therefore to provide immediate protection to existing wetlands.

2.2.2 Protection of Wildlife Habitat

Conversion of marsh in the project area from mostly fresh and intermediate in the 1940's (O'Neil, 1949) to nearly all brackish (Chabreck & Linscombe, 1988) and more recently to intermediate and fresh marsh (Chabreck et al., 1997) affects many wildlife species which use the marsh habitat in the project area. Drought conditions the past two years more than likely reversed the freshening conditions. Wetland losses increased the availability of shallow open water by approximately 34.9 square miles (9,039

hectares) per year in coastal Louisiana (Barras et al., 1994). Wetland loss in the project area from 1956 to 1990 is estimated at approximately 10,000 acres (4,050 hectares) or nearly 40 percent of the project area (Louisiana Coastal Wetlands Conservation and Restoration Task Force, 1993a). In addition to declining habitat quantity, habitat quality is changing also. Species diversity declines when fresher marsh types convert to more saline marsh; e.g., by the conversion of fresh and intermediate marshes to brackish marsh. Intermediate wetlands in the project area provide high quality habitat for nutria, raccoon, puddle ducks, and alligator (Palmisano, 1973, McNease and Joanen, 1978). Stabilizing habitat availability for wetland wildlife species requires slowing the rate at which wetlands convert to shallow open water and preventing the conversion of marsh to more saline conditions. Action is needed therefore to provide immediate protection to existing wetlands.

2.2.3 Protection of Fisheries Habitat

Fresh and intermediate wetlands are essential habitats for some fish species because wetlands provide refuge from predators and produce more small benthic invertebrates for fish to feed upon than unvegetated areas (Boesch and Turner, 1984; Rader, 1984; Rozas and Hackney, 1984, Rozas, 1993). Intermediate to fresh wetland losses in the project area, associated with conversion of marsh to open water areas, reduced the food supply for recreationally and commercially harvested fish species. The carrying capacity of many other wildlife, fish, and plant species is reduced as well. Action is needed therefore to protect and restore habitat critical to fish in the project area and statewide.

The brackish marsh in the project area also is essential fish habitat for many estuarine dependent marine organisms. Many species immigrate from offshore into the wetlands while still in the postlarval stage. The young organisms become widely dispersed and often concentrate at the interface between marsh and waterbodies where food is abundant and shelter available. Nearing adulthood, the organisms return to more saline or Gulf waters. Action is needed to protect brackish marsh and prevent more saline waters from encroaching in the project area and statewide.

2.2.4. Protection of Infrastructure

There are no state or parish roads within the project area, however, there are shell roads maintained for oil and gas production and numerous pipelines to transport those products. Erosion along the marsh/water interface is caused by tidal and wind-induced waves and currents. The roots of marsh vegetation stabilize the soils and provide cover to the buried pipelines as well as some protection to the shell roads in the project area and along the GIWW interface. Emergent vegetation in open water areas enhances sedimentation by slowing currents.

3.0 ALTERNATIVES INCLUDING PROPOSED ACTION

The area and scope of Black Bayou Hydrologic Restoration project were identified by NMFS as part of Task Force submittal on the sixth Annual Priority Project List. This project was the only one selected by the Task Force for the Calcasieu-Sabine Basin in 1997.

A DNR-contracted Preliminary Engineering Report was prepared by C.H. Fenstermaker & Associates, Inc. in December 1999 and revised in February 2000 (Contract No. 2511-99-19).

The range of alternatives for meeting the objectives for Black Bayou Hydrologic Restoration are discussed below. Consequences of the alternatives after implementation of the proposed action are discussed in Section 5.0

3.1 No-Action Alternative

The no-action alternative would fail to restore the bank line of the GIWW, thus allowing continued erosion caused by wave energy created by boats. The no-action alternative also would fail to protect the valuable marshes that provide habitat for numerous commercially and recreationally important aquatic and terrestrial species. The freshening trend, due to abundant rainfall of the early 1990's, was reversed under drought conditions at the end of the century, therefore, the conversion of marsh to open water probably would continue. The annual rate of marsh loss or gain would vary according to weather conditions, however the Louisiana Coastal Wetlands Restoration Plan projects a loss rate of 1.71 square miles per year for the period 1990 to 2010 (Louisiana Coastal Wetlands Conservation and Restoration Task Force, 1993). With the loss of vegetative habitats, there would be a continued decline in nursery and forage areas that provide much of the food (detritus, attached algae and sessile organisms, and small herbivorous and carnivorous residents) that comprises the basis of the food web. Without the dampening effect of the proposed weirs and boat bays, water currents would increase and more saline water would intrude farther into the project area. With increased salinities, the area of fresh marsh would return to conditions similar to that of 1988 or disappear; intermediate marsh would be stressed and areas of brackish and saline waters would increase.

3.2 Alternatives Considered

Background information necessary for developing the plans included the determination all vertical elevations. Project engineers used tide gauge station number 7696021 at the Intracoastal Waterway at Calcasieu Lock for this purpose. The calculated mean high water level over a 40-year period was +3.49 feet North American Vertical Datum 1988 (NAVD), and the mean low water level was calculated to be -1.68 feet NAVD. The marsh elevation was set at 1.1 feet NAVD. These figures were used throughout the engineering report (C.H. Fenstermaker & Associates, Inc., 1999 and 2000). A topographic survey was done around each of the proposed work sites. Survey data included some or all of the following as necessary to design the structure at that location: determining water depth, setting a tide gauge, determining where to tie into the existing bank line, plotting cross sections along the existing waterway, running a cesium magnetometer to check for existing pipelines, taking penetration depths to determine soil conditions within the canal, and setting "T" posts at 1,000 foot intervals. Information was analyzed with the three-dimensional cad program **Microstation**.

The initial scope of work as described in the draft Preliminary Engineering Design Report included the following items:

- 1) Restore the southern spoil bank of the GIWW west of Gum Cove Ridge with approximately 22,000 linear feet (6,700 meters) of foreshore rock dike with the intention to extend the rock dike completely across the mouth of the old natural Black Bayou;
- 2) Install a closure structure with a barge bay at the GIWW in the Black Bayou Cutoff Canal;
- 3) Replace several collapsed culverts under an existing shell road that is located along the southern boundary with the same material and size pipe with provisions to add flap gates on the south side and sluice gates on the north; (The existing culverts apparently were 42-inches (1.1 meters) in diameter corrugated metal pipe, however, only one of the three was in good enough shape to make this determination.)
- 4) Construct an earthen plug with culverts fitted with flap gates and sluice gates in the Vinton Drainage Ditch;

- 5) Construct a weir structure with boat bay in the Burton Canal at the confluence with the Sabine River;
and
- 6) Construct a weir structure with a boat bay on Blocks Creek at the confluence with Black Bayou.

During the planning phase, an existing weir structure collapsed and is no longer serviceable, therefore, necessitating the following replacement structure be added to the plans.

- 7) Construct a fixed-crest steel sheet pile weir with a self-regulating tide gate.

Various types of structures and different construction materials were considered for each location of proposed work. Hydraulic modeling (discussed below) helped to clarify the size, location, and type of structures which would best meet the goals of the project.

3.3 Hydraulic Modeling

Hydraulic modeling was used to assess the impacts of the seven (see Alternatives Considered above) proposed project components. Modeling allowed consideration of both water circulation patterns (water levels, flow velocities and directions) as well as changes in salinity within the modeled area. Also, modeling provided a means to determine the potential effectiveness of the proposed structural improvements in achieving the projects goals. The effect of normal conditions, droughts and tropical storms was evaluated, since the model could be used to predict time-varying water level and salinity conditions for various seasons and meteorological conditions at any number of points within the model domain. This introduction and the following discussion and conclusions were excerpted from the draft hydraulic modeling report submitted by Moffatt & Nichol Engineers (2000).

Existing data within the model vicinity (water level, salinity, wind, precipitation, discharge, and bathymetry) was collected from many sources and analyzed with the hydraulic model, **MIKE 11**, developed by the Danish Hydraulic Institute. **MIKE 11** is a professional engineering software package for the simulation of flows, water quality and sediment transport in estuaries, rivers, irrigation systems, channels and other water bodies. The hydrodynamic module, **MIKE 11HD** and the advection-dispersion module, **MIKE 11AD** also were used for vertically integrated equations of conservation of continuity and momentum, and conservation of mass of a dissolved or suspended material, respectively. Boundary conditions for the model included two of the six water level gauge records, one of the two salinity gauge records, three river discharge records, and rainfall and wind speed and direction records taken at Lake Charles Airport. The remaining four water level and one salinity gauge records were used as calibration points for the model. The model calibration for water level station statistics of 88 percent exceeded the general threshold criteria of 80 percent. Salinity station statistics (calibrated at 75 percent) did not quite reach threshold criteria, however they were deemed acceptable.

Modeling showed that existing conditions of water levels in; the east and west project sites are dependent on the tide at the Sabine and Calcasieu River gulf boundaries and tidal amplitude is typically damped further away from these tidal boundaries. Salinity propagates to the project sites in a different pattern from water levels.

Various project alternatives of proposed structural improvements were investigated for effectiveness, and concerns in the project vicinity (culverts with flap gates at the Vinton Drainage Ditch and configuration of the proposed structure at Site 7) were addressed with the model until results showed that the project goals were achieved. Project recommendations, and conclusions include:

- The culverts with flap gates at the Vinton Drainage Ditch were deemed unnecessary (Alternative 4 above). After modeling was performed both with and without culverts at the Vinton Drainage Ditch, the culverts were discovered to have little effect on water levels within the project area and discharged an insignificant amount of water compared to the Black Bayou Cutoff Canal.
- A self-regulating tide gate weir is the recommended structure at the site of the collapsed weir (Alternative 7 above). The recommended structure would be composed of a 40-foot wide weir with an elevation of +0.6 feet NAVD. (Because the hydraulic modeling and preliminary engineering plans are computed in English measurements only, no conversion to metric will be included in the technical sections.) The fish opening would be 10 feet wide and extend down to -4.0 feet NAVD. A tide gate would be placed over 8 feet of the 10-foot wide fish opening. The tide gate would allow water to flow freely in and out of the east project area under normal conditions. If the water level in Black Bayou gets above +1.3 feet NAVD, the tide gate closes and water flows over the structure and through the two 1-foot wide fish openings into the east project site, thereby reducing salt water intrusion and limiting water levels within the east project site. Once the water elevation in Black Bayou falls below +1.3 feet NAVD, the tide gate reopens allowing water to flow freely through the 8-foot wide weir and through the two fish openings. Water is allowed to flow freely over the weir anytime when the water level on either side is above +0.6 feet. This alternative reduces the water level as well as the salinity much more than any other alternative modeled while still allowing water levels to drop quickly after the storm surge subsides in Black Bayou.
- Additional culverts with flap gates at Shell Road (Alternative 3 above) are not required and are an added cost to the project. Discharges through the existing culvert compared with those at Site 7 show that additional culverts would provide only minimal drainage. Boat and barge bays have no negative effects on water levels in Black Bayou, and they cause minimal damping of the tide range in the west project area. The boat and barge bays have a small positive effect on reducing salinity in the west project area.
- Construction in the project area should be performed during a period when salinities are low. If the project is completed during a time when salinities are high in the east project area, then these salinities are expected to remain high for quite some time after the project is completed. However, if the project is constructed when salinities are low, then they will remain low after project completion.

Based on these findings and recommendations, it can be stated that the +0.6-foot NAVD, 40-foot wide weir with a 10-foot fish opening and 8-foot tide gate alternative in conjunction with the other project components will achieve the project objective of reducing salinity intrusion to improve aquatic habitat conditions, particularly with respect to marine fisheries.

3.4 Preferred Alternatives

This section presents the proposed action for the Black Bayou Hydrologic Restoration project. These plans were modified from the originally proposed alternatives to comply with the recommendations from hydraulic modeling. The following information was obtained from C.H. Fenstermaker & Associates, Inc. (2000), personal communication with their engineer and authorizing documentation of the Black Bayou CWPPRA project.

3.4.1 Project Feature Alternatives

To reduce wave energies across shallow open water areas, approximately 16 miles of vegetative plantings are recommended to be installed 1 year post-construction. Approximately 22,000 trade gallons of bullwhip or other suitable species would be planted east of Black Bayou Cutoff Canal to supplement CWPPRA project XCS-56 Plowed Terrace Demonstration project. Also 31,200 trade gallons of bullwhip are recommended to be planted west of Black Bayou Cutoff Canal in the series of shallow open water areas surrounding the Black Bayou Gas Field.

Site A - restoration of the southern spoil bank of the GIWW (Figure 3) would minimize the amount of bank line erosion caused by excessive wave energy being created by passing boat traffic and to restore historic hydrology to the area. The rock dike (see design details below) would tie into both the east and west banks of Black Bayou Cutoff Canal to allow boat traffic in and out of the GIWW and Black Bayou Cutoff Canal. The rock dike would extend 1,000 feet (300 meters) west of Black Bayou Cutoff Canal (Figure 4) and extend east approximately 32,830 feet (10,000 meters) for a total of 33,830 feet (10,300 meters).

Site B - installation of a weir with a barge bay in Black Bayou Cutoff Canal at the GIWW (Figure 5) would reduce the amount of salt-water intrusion into Black Bayou Cutoff Canal from the GIWW and reduce erosion caused by wave action from boat traffic within Black Bayou Cutoff Canal and surrounding marsh. The best location for the barge bay weir (see design details below) was determined to be 270 feet into Black Bayou Cutoff Canal from its intersection with the GIWW. The total width of the structure from the outer edge of each wingwall would be 270 feet. The existing bank lines of Black Bayou Cutoff Canal from the GIWW to the control structure would be lined with rock riprap (Figure 6).

Site C - construction of a weir with a boat bay in Burton Canal (Figure 7) would limit the amount of saltwater intrusion into the surrounding marsh and canals from the GIWW and the Sabine River and also limit wave action caused by nearby boat traffic. The weir (see design details below) with a 10 foot wide bottom width (Figure 8) would be located approximately 430 feet downstream of the intersection of Burton Canal and the Sabine River. The total width of the weir from the outer edge of each wingwall would be 155 feet. Additional work proposed at this site would be the closure of an existing slough located on the north bank of Burton Canal (Figure 8).

Site D - construction of a weir with a boat bay in Blocks Creek at its confluence with Black Bayou (Figure 9) would limit the amount of saltwater intrusion into the surrounding marsh and reduce tidal erosion. The location for this weir (see design details below) would be in Blocks Creek approximately 100 feet downstream of its intersection with Black Bayou. The total width of this structure would be 117 feet (Figure 10).

Site E - relocation and replacement of an existing weir (Figure 11) was not part of the original plan but became necessary after an existing weir collapsed. The weir would be relocated to an existing abandoned shell road which has an elevation of +5 feet and is approximately 80 feet wide (Figure 12). The collapsed weir would be plugged. The proposed structure would be a fixed-crest steel sheet-pile weir with a self-regulating tide gate (Figure 13). Spoil material (Figure 14) from installation of the weir would be placed in nearby open water areas to a height conducive to the establishment of marsh. Spoil from dredging the access route (Figure 15) also would be placed to marsh elevations (Figure 16).

3.4.2 Construction Alternatives

Rock Dikes - To keep construction costs at a minimum and achieve structural integrity of the rock dike at Site A, a 1.2 foot contour (Figure 4) was selected as a guide for the horizontal centerline placement of the rock dike base with the base a minimum of 15 feet from where the contour of the GIWW changes to a steep gradient (approximately -10.0 feet). A typical section of the proposed rock dike would be a triangular shape which would consist of a 10-foot wide base, 2:1 side slopes and a top elevation of +4.0 feet NAVD. Settlement plates would be placed at 1,000 foot intervals to monitor settlement that might occur. Rock dikes (Figures 7 and 9) other than along the GIWW would consist of rock riprap material with 2:1 side slopes and a top elevation of +4 feet NAVD that would tie into existing riprap material along the same bank and end at the proposed weir structure.

Barge and Boat Bay Weir - A barge bay weir at Site B (Figure 6), constructed from large riprap material was selected because of ease in construction and cost effectiveness. For structural stability, a geogrid material would be placed over the bottom sediments. The second layer in construction would be a 6-inch thick granular layer lining the entire channel to ensure interlocking between the geogrid and the rock riprap. Riprap would be the construction material for the remainder of the structure. The proposed barge bay structure would consist of a 70-foot wide notch with a bottom elevation of -9.0 feet NAVD. The boat bay weir at Site C (Figure 8) would have a bottom width of 10 feet at -4.0 feet NAVD and a top width of 58 feet. The boatbay weir at Site D (Figure 10) also would have a bottom width of 10 feet but the bottom would be at the -2.5 foot NAVD elevation. The top width would be approximately 48 feet. The top of all the weirs would be set at +4.0 feet NAVD to ensure that local boat traffic would be able to see the structures. Wingwalls would tie the structures into the existing banklines and provide material for the weirs if settlement occurs. All side slopes would be 3:1.

Fixed-crest Steel Sheet-pile Weir with a Self-Regulating Tide Gate (Figure 13) - Steel sheet pile, consisting of ASTM A 572, grade 50 steel with a maximum yield stress of 50,000 pounds per square inch, would be used to construct the headwall. The steel pilings would be prefabricated into a cross section with a 0.312 inch thickness in the web and flange of the piling. The sheet piling would be treated with a cold tar epoxy to resist rusting. To provide ingress and egress of marine organisms, two 1-foot wide fish openings would be located on either side of the tidegate (Figure 13). The site of the existing, but non-functional weir would be plugged with riprap (Figure 13).

A prefabricated self-regulating tide gate (Figure 17) would be inserted halfway along the centerline of the proposed weir structure. The tidegate would be 8 feet wide, 4.5 feet deep and have a top elevation of +1.3 feet NAVD. The self-regulating tidegate is hinged on the top of the fixed-crest sheet pile weir so that it floats on the surface of the water until it is closed by counter floats extending above and behind the hinge point. Figure 18 explains the operation of the self regulating tide gate.

4.0 AFFECTED ENVIRONMENT

The Black Bayou Hydrologic Restoration Project is located in Cameron and Calcasieu Parishes in southwest Louisiana. The project area is in the Calcasieu-Sabine Basin (Louisiana Coastal Wetlands Conservation and Restoration Task Force, 1993a) and Region 4 (Louisiana Coastal Wetlands Conservation and Restoration Task Force and the Wetlands Conservation and Restoration Authority, 1998). The project area (Figure 2), composed of 13,870 acres (5,610 hectares) of marsh and 11,660 acres (4,720 hectares) of water for a total of 25,530 acres (10,330 hectares), is south of the GIWW and east of Sabine Lake.

Region 4 extends from the Sabine Lake eastward to the Freshwater Bayou Canal and from just north of the GIWW to the Gulf of Mexico. This region of approximately 1,307,000 acres (528,900 hectares) has two basins, the Calcasieu-Sabine and the Mermentau. The smaller basin, Calcasieu-Sabine, is a shallow coastal wetland system composed of two large lakes, Sabine Lake on the western side and Calcasieu Lake to the east, with accompanying marshes. The Sam Rayburn and Toledo Bend reservoirs feed into Sabine River and Lake and the Calcasieu River into Calcasieu Lake. The Sabine-Neches Waterway, the Calcasieu Ship Channel, and the GIWW are major navigation projects in this basin. Federal refuges encompass about 24 percent of the basin wetlands and the largest, Sabine National Wildlife Refuge is south of the project area. Other managed wetlands within the basin include the Cameron-Creole Watershed and privately owned property.

In the Chenier Plain, the area of highest marsh loss is in the vicinity of Calcasieu and Sabine Lakes. Land loss rates for the Chenier Plain were 2.09 square miles (5.41 square kilometers) per year (Louisiana Coastal Wetlands Conservation and Restoration Task Force and the Wetlands Conservation and Restoration Authority, 1998 (after Dunbar et al. 1992)) in the 1940's, increased dramatically to 13.81 square miles (35.77 square kilometers) per year by about 1968 and declined to 7.61 square miles (19.71 square kilometers) per year in 1980 and 5.36 square miles (13.88 square kilometers) per year in 1988. The Louisiana Coastal Wetlands Restoration Plan projects a loss rate of 1.71 square miles per year for the period 1990 to 2010 (Louisiana Coastal Wetlands Conservation and Restoration Task Force, 1993). About 226,000 acres (91,500 hectares) of the original 893,300 acres (361,500 hectares) that existed in 1932 have converted to water. Although the westernmost portion of the Calcasieu-Sabine Basin is not in the USACE New Orleans District data base, Barras and coworkers, 1994) estimates that 18 percent or approximately 15,950 acres (6,460 hectares) were lost between 1978 and 1990. Major ship channels and the GIWW caused significant hydrologic alterations in the basin. In 1990, the Calcasieu-Sabine Basin was reported by the Louisiana Coastal Wetlands Conservation and Restoration Task Force and the Wetlands Conservation and Restoration Authority (1998) using data from Dunbar et al. (1992) to contain 317,100 acres (128,330 hectares) of marsh. Wetland loss projections using the 1974-1990 marsh loss rate for the Calcasieu-Sabine Basin are that 50,840 acres (20,580 hectares) would be lost by the year 2050 without restoration. With implementation of projects proposed in Louisiana Coastal Wetlands Restoration Plan and Coastal 2050, it is estimated that the loss of wetlands would be reduced to 38,400 acres (15,540 hectares) (Louisiana Coastal Wetlands Conservation and Restoration Task Force and the Wetlands Conservation and Restoration Authority, 1998).

The Black Bayou Hydrologic Restoration project is located in the northwestern corner of the Calcasieu-Sabine Basin in an area that has lost approximately 10,000 acres (4,050 hectares) of marsh. Hydrologic changes, including reduced freshwater inflow from the uplands north of the GIWW, increased magnitude and duration of tidal fluctuations, increased salinities, higher water levels, excessive water exchange, and artificial water circulation patterns are causes of the loss.

4.1 Physical Environment

4.1.1 Geology, Soils and Topography

The Black Bayou Hydrologic Restoration project is in northern part of the Chenier Plain away from the ridges which give this area its name. Pleistocene-age deposits form the geologic substrate of the Chenier Plain, including the project area. Most of the surface sediments are Holocene (recent) age with small remnants of Pleistocene age deposits (Gosselink et al., 1979). Alluvial sediments from the Mississippi and Red Rivers were transported westward along the coastline via littoral drift and deposited above Pleistocene age material (U.S. Department of Agriculture, 1995a).

The fragile soils in the project area are easily broken and dispersed by currents. Marsh soils are composed of fluid or firm sediments (mineral soils) and organic material (organic soils). These two classes are subdivided into three salinity groups - saline, brackish and fresh. The major soil associations in the project area are Morey-Mowata-Midland, Gentilly-Ged, Bancker, and Clovelly. All of these types share the characteristics of level, poorly drained soil. The Morey-Mowata-Midland association has a loamy surface layer and a loamy and clayey or clayey subsoil. Most of the land in this soil group is used for pasture or crops with a few homesites. Gentilly-Ged soils have a very fluid, mucky surface layer and slightly fluid to firm, clayey underlying soil. It occurs in brackish and freshwater marshes. Most of the acreage with this type of soil supports native wetland vegetation. Bancker and Clovelly soil types both occur in brackish marshes and have a very fluid, mucky surface layer over a fluid, mucky or clayey underlying layer. Since both of these soil types are ponded most of the time and are frequently flooded, they too support native wetland vegetation (U.S. Department of Agriculture, 1995b). Clovelly soil generally is found along Black Bayou and its tributaries, Bancker near Sabine Lake, and Gentilly-Ged soils surround Morey-Mowata-Midland soils in the central marsh area adjacent to and south of the GIWW.

The topography ranges from level to nearly level with elevations ranging from at or below sea level to about 11 feet (3.4 meters) above sea level on Perry Ridge. Most of the area is 1 to 1.5 feet (0.3 to 0.5 meters) above sea level.

4.1.2 Climate and Weather

Cameron Parish is in a region characterized by a humid, subtropical climate. It is characterized by long, hot and humid summers and short, mild and humid winters. Average daily maximum temperatures from May to October range between 83.7° and 90.7° Fahrenheit (F) and the average daily minimum temperatures for the same period range from 65.6° to 73.4°F. Average daily maximum and average daily minimum winter temperatures between November and April range from 60.2° to 78.2°F and 41.9° to 59.7°F, respectively (U.S. Department of Agriculture, 1995b). The average relative humidity in midafternoon is about 60 percent. Humidity is higher at night and the average at dawn is about 90 percent. The prevailing wind is from the south with highest average windspeed 10 miles (16 kilometers) per hour in spring.

The total annual precipitation is approximately 52 inches (1.3 meters) with about 55 percent during April through September. Thunderstorms occur on about 80 days each year. A hurricane crosses the parish every few years and a few have been extremely severe. Less rainfall usually occurs in February and March. Snow rarely occurs and is seldom on the ground for more than a day. The growing season for the project area varies between 259 and 313 days. (U.S. Department of Agriculture, 1995b).

4.1.3 Air Quality

Air quality of the project area is good. Air masses are unstable in this area due to the proximity to the coast and the influence of the Sabine River and Lake. There are minimal automotive air emissions from the few vehicles traveling along shell roads. Boat engines, ranging in size from small trolling motors to those of tug boats maneuvering barges on the GIWW, probably contribute the greatest amount of air emissions. Also there is a small amount of emissions from the oil or gas production activity in the project area.

4.1.4 Surface Water Resources

Cameron Parish has 354,920 acres (143,640 hectares) of surface water. The Sabine River, which forms one border of the project area, is the largest source of surface water in the parish. However

the timing of freshwater input into the Sabine Estuary has been altered for the generation of electricity at the Toledo Bend Dam on the Sabine River and the Sam Rayburn Dam on the Neches River. Black Bayou, which enters the upper part of Sabine Lake, is the largest secondary stream in the project area. The Louisiana Department of Environmental Quality (1999) report on water quality for 1998 shows that these water bodies and watercourses are fully supporting designated uses for primary and secondary contact recreation and propagation of fish and wildlife, agriculture.

There are approximately 11,660 acres (4,720 hectares) of shallow open water and broken marsh within the project area. Much of the open water is turbid and approximately 25 percent of the water surface is covered by floating vegetation.

Water Quality Produced water, or oil-field brine is a by-product of crude oil or natural gas. This saline water (35 to 200 ppt) either was re-injected into a well or discharged into surface waters prior to 1997 when compliance to EPA's no-discharge of produced water became effective. Boesch and Rabalais (1989) reported a total discharge of approximately 60,000 barrels per day in the Sabine Basin, two thirds of which was in brackish marsh and the remainder in fresh marsh. There may be pockets of abnormally high soil salinities in areas where brine was discharged, but water salinities should be unaffected after several years of ambient salinities.

Salinity Both Sabine Lake and Black Bayou are tidally influenced and, therefore, have a variable salinity. Salinities during summer months are affected by water discharges for electricity production from the Sam Rayburn Reservoir Dam on the Neches River and the Toledo Bend Dam on the Sabine River. Salinities in the project area range from brackish near the Lake to intermediate in the central area and fresh in the easternmost part (near Gum Cove Ridge) of the project. The range in salinity of a brackish marsh is from nearly fresh (0.4 parts per thousand) to 28 parts per thousand with a mean of 8 parts per thousand (U.S. Department of Agriculture, 1977). Brackish marsh is strongly influenced by tidal effects. The inland movement of more saline water serves to determine the type of vegetation of the marsh, aids in recirculating nutrients, and facilitates the inland migration of larval organisms. Intermediate marshes occur between brackish and fresh marsh and, in Louisiana, have the smallest acreage of the four marsh types. The salinity range of intermediate marsh is from 0.39 to 9.80 parts per thousand with a mean of 3.3 parts per thousand. Fresh marshes are usually the most inland and the vegetation is the least salt tolerant. Salinities range from 0 to 5 parts per thousand.

The Galveston District, Corps of Engineers, is presently conducting a feasibility study addressing the possible deepening and widening of the Sabine-Neches Waterway, located along the western portion of Sabine Lake. Such channel deepening has the potential for increasing salinities in Sabine Lake and Black Bayou.

A series of vegetative maps included in U.S. Department of Agriculture report (1994) shows that salinity has changed drastically in the project area since 1931. Vegetation near Sabine Lake was predominately bulrush, saw grass, wiregrass, cane and grazing areas and the area was noted as fresh to intermediate marsh. By 1949, the vegetative map showed brackish three-cornered grass marsh near Sabine Lake, most of the area as intermediate marsh and fresh marsh along the easternmost part of the project area. Hurricane Audrey flooded most of Cameron Parish with

brackish water in late June 1957. Saw-grass in western Cameron Parish died during 1958 through 1961 as a result of that flooding followed by 4 years of drought (Valentine, 1976). By 1968, brackish marsh vegetation extended from Sabine Lake to near Perry Ridge. Intermediate marsh composed the center of the project area and there was still some fresh marsh near the GIWW on the eastern part of the project area. The brackish vegetative zone on the 1978 map had expanded eastward along Black Bayou, reducing the intermediate and fresh marsh areas. The latest map in the series, 1988, showed even more brackish marsh vegetation and diminished intermediate and fresh marsh areas. Updated vegetative maps (Chabreck et al., 1997) show a reversal in the long-term salinity trend toward more saline marsh with an increase in intermediate and fresh marsh vegetation. As noted previously, however, the rainfall shortage of the past two years probably has caused a salinity increase that has adversely affected the vegetation. These drastic changes over the last 70 years are the result of natural and man-made causes.

4.2 Biological Environment

4.2.1 Vegetative Communities

The project area was visited by the Wetland Value Assessment team in December 1992 during the planning phase of this project. The team divided the area into two habitat types - brackish and fresh/intermediate. Brackish marsh vegetation was dominated by marshhay cordgrass *Spartina patens* (35 to 90 percent) with black needlerush, *Juncus roemerianus* (trace to 5 percent), roseau cane *Phragmites australis* (trace to 5 percent), three-corner grass *Scirpus olneyi* (0 to 40 percent), leafy three square *Scirpus robustus* (trace to 10 percent), and cattail *Typha* sp. (trace to 5 percent) occurring in significant amounts sporadically.

The fresh to intermediate marsh also had marshhay cordgrass (50 to 80 percent), black needlerush (trace to 30 percent), roseau cane (5 to 10 percent), California bullwhip *Scirpus californicus* (0 to 5 percent), leafy three-square (5 percent) and cattail (0 to 10 percent). Spoil banks of the Sabine River and the GIWW are vegetated with Chinese tallow *Sapium sebiferum*, sugar berry *Celtis laevigata*, and black willow *Salix nigra*.

Submerged aquatic vegetation occurs in many open water areas. Eurasian water milfoil *Myriophyllum spicatum* and coontail *Ceratophyllum demersum* were the most abundant with coverage of 5 to 40 percent of individual areas. Other open water areas had up to 50 percent coverage of eelgrass *Vallisneria americana*; 5 to 10 percent of pond lily *Potamogeton* sp.; or 5 to 20 percent of wigeon grass *Ruppia maritima*, respectively.

4.2.2 Essential Fish Habitat

Under the Magnuson-Stevens Fishery Conservation and Management Act, the Gulf of Mexico Fishery Management Council identified essential fish habitat for those species managed under its fishery management plans for coral and coral reefs, spiny lobster, stone crab, coastal migratory species, reef fish, red drum, and shrimp (Gulf of Mexico Fishery Management Council, 1998). The Council's essential fish habitat amendment was partially approved by the National Marine Fisheries Service in February 1999. Habitats in and near Black Bayou, including adjacent areas that could be affected by construction and benefit from the proposed action, are now recognized

as essential fish habitat for eggs, larvae, juveniles, adults, and spawning adults. Managed species, their essential habitat requirements, and their period of habitat use in the Black Bayou area, including Sabine Lake, include: brown shrimp *Penaeus azetecus* postlarvae and juveniles - marsh edge, submerged aquatic vegetation, tidal creeks, and inner marsh (year round); brown shrimp subadults - mud bottoms and marsh edge (year round)(Lassuy, 1983); red drum *Sciaenops ocellatus* postlarvae and juveniles - submerged aquatic vegetation, mud bottom, marsh edge (year round); red drum subadult/adult - mud bottom and oyster reef (year round)(Buckley, 1984); white shrimp *Penaeus setiferus* postlarvae, juveniles, subadults - marsh edge, submerged aquatic vegetation, marsh ponds, inner marsh and oyster reefs (year round)(Turner and Brody, 1983); and white shrimp adults (March through May).

The proposed action is designed to restore coastal marsh habitat and slow the conversion of wetlands to open water. When completed, the reduced cross-sectional areas of Black Bayou, Burton Canal and Blocks Creek, plus the self-regulating tide gate would dampen water surges and reduce salinities, especially in the eastern portions of the project area. All structures are designed to allow fishery ingress and egress along historical or more natural routes. The rock dike along the GIWW would reduce wave-generated erosion by containing boat wakes in the GIWW. As the result of the dike and structures, water currents would be reduced throughout the project area and sedimentation would increase, thus enhancing marsh vegetation.

Projects like this hydrologic restoration effort are recommended in the essential fish habitat amendment (Gulf of Mexico Fishery Management Council, 1998) as the most viable approach to large-scale habitat protection and restoration in coastal Louisiana. The Black Bayou Hydrologic Restoration project will help to ensure the long-term sustainability of important habitats and the managed species that depend on those habitats during some stage in their life. The need for restorative action in this area has been recognized for many years and was selected by a public process that offered ample opportunity for public input and debate prior to funding through the CWPPRA process.

4.2.3 Fishery Resources

Marine fish and shellfish such as the Atlantic croaker *Micropogonias undulatus*, spot *Leiostomus xanthurus*, menhaden *Brevoortia patronus*, bay anchovy *Anchoa mitchilli*, brown shrimp, and white shrimp occur in the estuarine waters of the project area (Herke, 1978, Rogers et al., 1993). Even fish species that do not swim in flooded marshes may depend on marshes to complete part of their life cycle because detritus originating from wetland vegetation provides food for juvenile fish (Deegan et al., 1990). Menhaden, which constitute part of the largest commercial fishery in the contiguous United States, illustrate one of the many possible relationships between fish and wetlands. Menhaden spend most of their life in deep water where they are harvested, but juvenile menhaden grow and develop in estuaries where detrital marsh vegetation is an important food source (Deegan et al., 1990). Juvenile menhaden, in turn, are an important food source for carnivorous fish, turtles, and many fish-eating birds, including the pelican, the State Bird of Louisiana.

Aquatic resources of national importance found near the project site include Atlantic croaker, red

drum, sand seatrout *Cynoscion arenarius*, spotted seatrout *Cynoscion nebulosus*, southern flounder *Paralichthys lethostigma*, gulf menhaden, spot, striped mullet *Mugil cephalus*, brown shrimp, white shrimp, and blue crab *Callinectes sapidus* (Hoese, 1976). These resources are species of national economic importance in accordance with Section 906(e)(1) of PL 99-602, the Water Resources Development Act of 1986. These species vary in abundance from season to season due to their migratory life cycle. Most spawn offshore in the open Gulf of Mexico and enter Sabine Lake as larvae or young juveniles to use the shallow bay bottoms and brackish marshes as a nursery. Usually these species return to the open gulf as subadults or adults.

Freshwater fish species such as largemouth bass *Micropterus salmoides*, blue catfish *Ictalurus furcatus*, channel catfish *Ictalurus punctatus*, yellow bass *Morone mississippiensis*, bluegill *Lepomis macrochirus*, redear sunfish *Lepomis macrochirus*, and crappie are caught in low salinity waters. Commercial species such as the catfishes *Ictalurus* sp.; the American eel *Anguilla rostrata*, which is an important export commodity; and baitfish (e.g., *Fundulus* sp., and *Poecilia* sp.) also are harvested from the Sabine River.

The Eastern oyster *Crassostrea virginica* supports an important commercial fishery from the Gulf of Mexico to the Gulf of St. Lawrence. Oysters are euryhaline and complete the entire life cycle within an estuary. Water currents, bottom substrate, and tidal flushing are critical to sustaining a natural oyster population (Stanley and Sellers, 1986). Rising water temperatures during flood tides stimulate setting. Oyster larvae set in established oyster beds or on firm substrates in suitable salinities. Survival to adults is dependent on temperature, salinity, intertidal exposure, turbidity and food. In the Gulf region, best growth and reproduction is in oyster reefs with a salinity of 12 to 30 parts per thousand, but oyster abundance is greatest at 10 to 20 parts per thousand (Stanley and Sellers, 1986). Optimum water temperatures for growth, reproduction, and survival of American oysters range from about 20° to 30° C (68° to 86° F). Most oysters harvested from this basin are from Calcasieu Lake, however, there are some oysters harvested from Sabine Lake. There are no oyster leases in the project area.

4.2.4 Wildlife Resources

Coastal wetlands in Louisiana provide high quality habitat for the American alligator *Alligator mississippiensis*, furbearers such as nutria *Myocastor coypus*, muskrat *Ondatra zibethicus*, raccoon *Procyon lotor*, mink *Mustela vison*, and river otter *Lutra canadensis*, game such as white-tailed deer *Odocoileus virginianus*, rabbit *Sivillagus* sp., squirrel *Sciurus* sp., and snapping turtle *Macrolemys temmincki* (Bellrose, 1976; McNease and Joanen, 1978; and Palmisano, 1973).

Geese (snow goose *Chen caerulescens*, Canada goose *Branta canadensis*), dabbling ducks (mallard *Anas platyrhynchos*, northern pintail *Anas acuta*, gadwall *Anas strepera*, blue-winged teal *Anas discors*, mottled duck *Anas fulvigula*, green-winged teal *Anas crecca*, and American wigeon *Anas americana*) and diving ducks (lesser scaup *Aythya affinis*, greater scaup *Aythya marila*, red-breasted merganser *Mergus merganser*, ring-necked duck *Aythya collaris*, redhead *Aythya americana*, canvasback *Aythya valisneria*, and bufflehead *Bucephala albeola*) are abundant in the Sabine Basin. Most of these waterfowl breed in the northern plains and migrate to the coastal marshes of Louisiana for the winter. Geese are primary grazers and feed on rice, bulrush and marshhay cordgrass. Puddle ducks feed in water up to 15 inches (0.4 meter) deep

and diving ducks in deeper water. Only the mottled duck nests within the project area (Condrey et al., 1995; U.S. Department of Agriculture, 1994).

In 1990 a census of wading birds and seabird nesting colonies was conducted in Louisiana. Twenty-seven species of colonial nesting waterbirds were studied (Martin and Lester, 1990). The closest documented nesting site to the project area is located about 1.5 miles (2.4 kilometers) south of the shell road on the southeastern border of the project area. Nests were located in individual trees or shrubs in an area classified as mainland marsh. The colony was not surveyed in 1976 or 1978. In 1983, species of birds noted were anhinga *Anhinga anhinga*, olivaceous cormorant *Phalacrocorax olivaceus*, cattle egret *Bubulcus ibis*, snowy egret *Egretta thula*, great egret *Casmerodius albus*, and great blue heron *Ardea herodias*. The colony size was estimated to contain between 100 and 500 birds which decreased to less than 100 birds in 1990. Seabirds feed mostly within the shallow bays and the near coastal waters on small fish, therefore, are not common in the project area. Wading birds live in coastal marshes and swamps, and most feed on small fish, insects, frogs, and snakes. Wading birds such as the great blue heron, great egret, little blue heron, snowy egret, cattle egret, white ibis, and black-crowned night-heron are common in the Calcasieu-Sabine Basin (U.S. Department of Agriculture, 1994).

4.2.5 Threatened and Endangered Species

The current list of endangered or threatened species was reviewed as part of this assessment (U.S. Fish and Wildlife Service, 1999). The project area is in the defined range for eagles and sea turtles. The bald eagle *Haliaeetus leucocephalus* was nearly driven to extinction in Louisiana due to a buildup of DDT toxins but has rebounded since the ban on its use. According to the FWS data base (D. Clark, personal communication), a bald eagle nest is located in Calcasieu Parish approximately 8 miles north of the center of the project area. Wintering eagles have been sighted in Cameron Parish at the Lacassine National Wildlife Refuge and near Sweet Lake. The migratory piping plover *Charadrius melodus* population has been declining since the 1950's and is uncommon during the winter in Louisiana. The brown pelican *Pelecanus occidentalis*, formerly extinct in Louisiana, has been reintroduced and is now increasing in numbers, especially in the southeastern part of the state. The Eskimo curlew *Numenius borealis* migrates from Alaska to Argentina and occasionally may pass through Louisiana during the spring migration. The population of least terns *Sterna antillarum* found in the southern, coastal area is not listed as endangered, only the northern interior population (Condrey et al., 1995).

Although the northern Gulf of Mexico is within the range of five species of sea turtles, the Kemp's ridley *Lepidochelys kempi*, which is a federally-listed endangered species, is the only one that feeds on crabs, clams, snails, fish jellyfish and barnacles in shallow coastal waters (Condrey et al., 1995). Although a long distance from the Gulf, marshes and open water areas of the project area rarely might serve as foraging and development sites for the Kemp's ridley sea turtle. Dundee and Rossman (1989) report that Kemp's ridley occasionally appears along the Louisiana Gulf coast. Possible factors related to this occurrence include the widespread availability of shallow water marine and estuarine habitat with high turbidity levels from proximity to the Mississippi and Atchafalaya Rivers (Frazier, 1980).

None of the other four species of endangered sea turtles are expected in the project area. The loggerhead turtle *Caretta caretta* and the green turtle *Chelonia mydas* are relatively common in the nearshore waters of the Gulf of Mexico. The loggerhead feeds on sponges, jellyfish, mollusks, crustaceans, sea urchins, fishes, seaweeds and grasses while the green turtle's diet is primarily marine grasses and macrophytic algae. The hawksbill turtle *Dermochelys coriacea* is usually found in sea waters less than 50 feet (15 meters or 8 fathoms) and feeds on invertebrates, marine grasses and macrophytic algae. The leatherback turtle *Dermochelys coriacea* is found in deeper oceanic waters and feeds primarily on jellyfish (Condrey et al., 1995).

4.3 Cultural Environment

4.3.1 Historical or Archaeological Resources

Native Americans of the Attakapas Tribe lived along the cheniers and possibly along the shore of the Gulf of Mexico prior to the European colonization. Cabeza de Vaca was probably the earliest explorer of Cameron Parish and possibly some of DeSoto's people crossed the area en route from the Mississippi River to the Spanish colonies in Mexico. During the seventeenth and eighteenth centuries, the area between Sabine and Calcasieu Lakes was claimed, but not governed, by both Spain and France and was a haven for outlaws. This neutral strip was ceded to Spain in 1762 and 41 years later returned to France. The same year, 1803, the French sold Louisiana to the United States. Anglo-Saxons and Celts settled the southern part of the parish during the 1830's. Exiled residents of French Acadia, now Nova Scotia, settled in what is now Ascension and St. James Parishes and became the source of the "Acadians". However, it was not until near the middle of the nineteenth century that they moved into the northern part of Cameron Parish (U.S. Department of Agriculture, 1995b).

Fishing, farming and trading, especially furs, were the occupations of the first settlers. Exploration for oil and gas resources first occurred during the early part of the 20th century. The construction of canals to provide access for a barge-mounted drilling rig drastically changed the landscape of coastal Louisiana. Turner and Cahoon (1988) estimated that 6,953 miles (11,190 kilometers) of canals crossed the coastal plain of Louisiana. Discovery of the Black Bayou Saltdome in 1927 led to the development of the Black Bayou Oil and Gas Field and dredging many canals and slips.

There are 19 archaeological sites listed in the Sabine-Black Bayou Watershed area (U.S. Department of Agriculture, 1995b). These sites include 16 shell middens, 2 prehistoric scatter sites and 1 shell lens with a camp. Most of the sites have been disturbed by either dredging, wave wash, construction or subsidence (U.S. Department of Agriculture, 1995b).

4.3.2 Economics (Employment and Income)

With so much of the area classified as wetlands, the economy of the project area is dependent upon the commercial and recreational harvest of furbearers, alligators, finfish and invertebrates.. More than 40 percent of the total wild fur harvested in the United States comes from Louisiana's wetlands. During the 6-year period from 1977 through 1982, the average

production from Cameron Parish was 113,780 nutria, 35,960 muskrat, 3,771 raccoon, 1,574 mink and 467 otter (Linscombe and Kinler, 1985).

The southwestern marshes of Louisiana produced the highest nesting density for alligators (one nest to 90 acres (36.5 hectares), with the greatest density in intermediate marsh, followed by fresh and brackish marsh (McNease et al., 1994). Total coast wide marsh nest projections during 1970-1993 ranged from a low of 6,700 to a high of 34,500 with an increasing trend over time. Alligator management and harvest programs in the Black Bayou area yielded an estimated \$166,279 in 1994 (U.S. Department of Agriculture, 1995b).

About 90 percent of the fish harvested from the Gulf of Mexico rely on aquatic habitats such as those found in the marshes of the project area. There are two major commercial fishery ports near the project area. Cameron, Louisiana, is located east of Black Bayou on Calcasieu Lake near the Gulf of Mexico and Port Arthur, Texas, is located west of the project area on Sabine Lake. These two ports reported 272 million pounds of fishery products landed in 1998; 389.1 million pounds in 1997; and 327.7 million pounds in 1996 (U.S. Department of Commerce, 1997, 1999). For value of commercial fishery landings the same two ports are listed in the top 25 in the United States. Dockside value at these ports was \$62.4 million in 1998, \$59.0 million in 1997; and \$57.6 million in 1996 (U.S. Department of Commerce, 1997, 1999).

In addition to the economic impact from the commercial fishing industry, revenue is generated from recreational wildlife and fisheries activities in or near the project area. Businesses in Cameron and Calcasieu Parishes, Louisiana, and Jefferson and Orange Counties, Texas, market equipment, bait, food, and gas necessary for trips to the Gulf of Mexico, Sabine Lake and surrounding wetlands.

Oil and gas exploration has been conducted in Cameron Parish for about 50 years. Parish revenues and employment resulting from oil and gas exploration and production reached their highest level between 1970 and 1985. There were 458 wells in Cameron Parish or approximately 10 percent of the wells south of the Intracoastal Canal of Louisiana in 1994 (Mid-Continent Oil and Gas Association, 1995). Following the decline in the oil and gas industry since the mid-1980s, the economic benefits resulting from oil and gas exploration have decreased also. Approximately 830 people were employed in the oil and gas industry in 1994.

Rice is the principal cash crop with livestock the second most important source of agricultural income.

4.3.3 Land Use

Cameron Parish contains 1,204,000 acres (487,260 hectares) of which 82 percent is coastal marsh (U.S. Department of Agriculture, 1995b) The Calcasieu-Sabine River Basin contains about 468,000 acres (189,400 hectares), however, about 7,000 acres (2,830 hectares) are in Calcasieu Parish south of the GIWW (U.S. Department of Agriculture, 1994). In 1982 and 1987, there were 260,000 and 255,400 acres (105,200 and 103,360 hectares) respectively of farm land, however, over 75 percent was classified as marsh rangeland. There were no commercial woodlands in the parish. Most of the urban land in the Calcasieu-Sabine Basin is along the

cheniers or was developed from cropland (U.S. Department of Agriculture, 1994).

The U.S. Department of Agriculture (1995b) Black Bayou Watershed study reported 95 percent of the 41,700 acres (16,880 hectares) of land in their project area as non-forested wetlands, 2 percent forest, and 3 percent urban. The urban classification included the oil and gas fields on the eastern side of the project area.

4.3.4 Recreation

Sabine River and Lake, Black Bayou and project area marshes provide varied recreational opportunities for local and visiting fishermen and boaters, trappers, hunters for both waterfowl and furbearers, bird watchers, and campers. Access is by boat since there are no roads, other than the oil field access road, in the project area.

4.3.5 Noise

Black Bayou has no industry other than the oil and gas fields on the eastern end of the project area. Ambient noise in the area would originate from oil and gas exploration and production, boats on the river, lake and GIWW, people hunting or fishing in the area and wildlife.

4.3.6 Infrastructure

There are no county or state roads in the project area. There is an oil field road which runs southwesterly from Black Bayou Oil and Gas Field and a shell road which forms the southeastern border of the project area. There are numerous pipelines in the area, especially around Black Bayou Oil and Gas Field. Those located immediately in the vicinity of construction sites are a Department of Energy, Strategic Petroleum Pipeline at Site B. The six pipelines crossing Burton Canal (Site C) are two Colonial Pipelines, an 8-inch diameter Transcontinental Pipeline, a 16- and 18- inch diameter Sabine Pipeline, and a 16-inch diameter Texaco Pipeline. Other pipelines in the project area include an 8-inch diameter PPG Industries pipeline, an 18-inch diameter Texaco pipeline, and 30-, 16-, and 6-inch diameter lateral pipelines tied to a 36-inch diameter Williams pipeline.

5.0 ENVIRONMENTAL CONSEQUENCES

The adverse environmental consequences of the no-action alternative are extensive compared to the benefits of the preferred plan. Mathematical modeling (Moffatt & Nichol Engineers, 2000) of water circulation patterns (water levels, flow velocities and directions) as well as changes in salinity within the modeled area predicts that the completed project would meet objectives. The Black Bayou Hydrologic Restoration project would restore approximately 33,800 feet (10,300 meters) of the southern spoil bank of the GIWW west of Gum Cove Ridge. A barge bay and two boat bay structures would have a small positive effect in reducing the amount of saltwater intrusion into the Black Bayou project area and would limit erosion caused by wave action from boat traffic. A self-regulating steel fixed-crest weir would reduce salinity intrusion and improve aquatic habitat conditions, particularly with respect to marine fisheries. Without construction, the project area wetlands would continue to convert to open water. Fish and wildlife resources

would decline with the concurrent loss of habitat.

5.1 Physical Environment

5.1.1 Geology, Soils and Topography

The proposed activity will have minimum impact on the geology and soils of the Black Bayou project area. Repair of breaches along the GIWW would return the topography similar to that which previously existed. Vegetative plantings would stabilize soil and encourage sedimentation. Material used for construction of the shoreline stabilization would be free of contaminants. Impacts from construction would be minimal, localized and short-term.

5.1.2 Climate and Weather

Inclement weather could temporarily delay the implementation of the proposed activities. Construction of the rock foreshore dike, barge and boat bay weirs and self-regulating fixed-crest weir would provide increased protection from water currents and waves caused by wind and storms. The structure at Site E would be constructed during a period of low salinity to retain the fresh water.

5.1.3 Air Quality

Exhaust emissions from construction equipment would be temporary and minor. Airborne pollutants would be dissipated quickly by prevailing winds and be limited to the construction phase of the project.

5.1.4 Surface Water Resources

Impacts to surface waters would be minor and would occur only at the construction sites and during the construction phase of the project. Increased turbidity would occur during construction of the foreshore dike, barge and boat bay weirs, and the self-regulating fixed-crest weir.

Water Quality: There would be no adverse impacts to water quality within the project area.

Salinity: The proposed structures would reduce high salinity surges in the project area and gradually return the area to historical conditions.

5.2 Biological Environment

5.2.1 Vegetative Communities

The proposed activity would result in positive long-term impacts on vegetative communities within the project area. Re-establishing the hydrology of Black Bayou would reduce salt water intrusion and maximize freshwater retention. Since the dredged material would be deposited at

elevations conducive to the establishment of marsh vegetation, those sites should vegetate quickly, thus slightly increasing the area of marsh.

5.2.2 Essential Fish Habitat

In the long term, the proposed activities would improve essential fishery habitats by reestablishing marsh and protecting existing marsh. Marsh and marsh edge habitat would be increased with the survival and growth of the vegetation to be planted after structure completion. Detrital material, formed by the breakdown of emergent vegetation, would contribute to the aquatic food web of Sabine Lake and near-shore Gulf of Mexico ecosystems.

Short-term adverse impacts to shrimp and red drum would occur during the construction phase of the project. Approximately 0.5 acre of marsh edge habitat would be impacted by fill placement. Other temporary impacts include entrapment of slow-moving organisms during construction and increased turbidity in waters near the designated construction sites. These impacts are minor and would be limited to the immediate vicinity of action and only for the duration of construction of the project.

5.2.3 Fishery Resources

Short-term adverse impacts to fishery resources would occur during the construction phase of the project. These impacts include entrapment of slow-moving organisms and benthic animals during dredging, and smothering of non-mobile benthic organisms in the deposition sites. Deposition of the rocks for the foreshore dikes would crush benthic organisms. Increased turbidity would occur in waters near the designated construction sites. These impacts are minor and would be limited to the immediate vicinity of action and only for the duration of construction of the project. The rocks would provide different habitat for sessile or attached plants and animals.

5.2.4 Wildlife Resources

The proposed activities would improve wildlife habitats by reestablishing and maintaining marsh. Alligator, furbearers and game would benefit from improved marsh. Reduction of water currents in open water areas would enhance growth of submerged aquatic vegetation thus providing additional food for many waterfowl.

During the construction phase of the project, furbearers, game, and waterfowl would avoid the area, but would return after cessation of activity.

5.2.5 Threatened and Endangered Species

Although bald eagles have been recorded as nesting in Calcasieu Parish and have been observed in Cameron Parish, no adverse impacts would be anticipated to this threatened species. More than likely, construction would take place during the warm weather months when other endangered birds would not be expected in the area, therefore, there would be no adverse impacts to them. Although not likely to occur in the project area, if Kemp's ridley or other sea turtles

ventured into the region, they probably would avoid the increased turbidity and activity surrounding construction sites.

5.3 Cultural Environment

5.3.1 Historical or Archaeological Resources

No impacts would be anticipated to historical or archaeological resources within the project area since existing archaeological sites are not located near construction areas.

5.3.2 Economics (Employment and Income)

No adverse impacts to economic resources would result from the proposed project. Nearby businesses would continue to profit from supplies necessary to reach fishing, hunting, or other recreational areas. Project construction would provide temporary employment. The oil and gas industry would not be affected by the project.

5.3.3 Land Use

No adverse impacts to current land use would result from the proposed activity.

5.3.4 Recreation

Minor temporary adverse impacts to recreation would occur as a result of construction activity. These include increased turbidity of surface waters and increased noise within the project area during the time of construction. The barge and boat bays would allow continued access into Black Bayou, Burton Canal and Block's Creek. Improved habitat also would improve the carrying capacity of the wetlands, thus sustaining or increasing fish and wildlife for fishermen or hunters.

5.3.5 Noise

Short term adverse impacts, limited to the construction phase, include increased noise associated with supply boats and construction machinery.

5.3.6 Infrastructure

There would be no adverse impacts to infrastructure. Structures at Sites B and C would be located far enough away from the pipelines to avoid impacts. The reduction in cross-sectional area of Burton Canal would be less inviting for shrimp boats to lodge in the entrance, thus reducing the amount of prop wash that scours the sediments over the pipelines.

6.0 CONCLUSIONS

This EA finds that no significant adverse environmental impacts are anticipated by the implementation of the Black Bayou Hydrologic Restoration project. This conclusion is based on a comprehensive review

of relevant literature, site-specific survey data, hydraulic modeling, and project-specific engineering reports. This finding supports the recommendation of the CWPPRA Task Force, including NMFS, the sponsoring agency. As evidenced by their funding, the State of Louisiana supports the project. Construction of the project has been encouraged by the Cameron and Calcasieu Parish governments and the general public. The natural resource benefits anticipated from the implementation of the Black Bayou Hydrologic Restoration project would enhance and sustain the diverse ecosystem found within the Sabine Basin. NMFS believes that existing essential fish habitats in the Black Bayou area would be maintained and that the vegetative plantings would increase marsh and marsh edge habitats.

7.0 PREPARERS

This EA was prepared by GOTECH, Inc. under contract to NMFS. Mr. Bruce Dyson of GOTECH, Inc. provided administrative duties and the production of figures and Ms. Peggy Jones wrote most of the text with generous help from Mr. John Foret and Dr. Andrew Nyman. C.H. Fenstermaker & Associates supplied the engineering drawings. Direction, guidance and invaluable reference materials were provided by Mr. John Foret, Ms. Joy Hunter and Dr. Teresa McTigue of NMFS. Mr. Richard Hartman, Mr. Patrick Williams, Dr. Erik Zobrist of NMFS also supplied information as did Ms. Faye Talbot, Mr. Marty Floyd, Mr. Britt Paul and Mr. Doug Miller of NRCS, and Mr. Gerry Bodin and Mr. David Fruge of FWS.

8.0 FINDING OF NO SIGNIFICANT IMPACT

Based on the conclusion of this document and the available information relative to Black Bayou Hydrologic Restoration project, including hydraulic modeling, there would be no significant environmental impacts from this action. Furthermore, preparation of an Environmental Impact Statement on this action is not required by the National Environmental Policy Act or its implementing regulations.

Roland A. Schmitten
Assistant Administrator for Fisheries
National Marine Fisheries Service

Date



UNITED STATES DEPARTMENT OF COMMERCE
National Oceanic and Atmospheric Administration
 NATIONAL MARINE FISHERIES SERVICE
 1315 East-West Highway
 Silver Spring, MD 20910

THE DIRECTOR

JAN - 3 2001

MEMORANDUM FOR: Susan B. Fruchter
 NEPA Coordinator
 Office of Policy and Strategic Planning

FROM: *W. Dalton*
for Penelope D. Dalton

SUBJECT: Finding of No Significant Impact on the
 Environmental Assessment for the Black Bayou
 Hydrologic Restoration Project, Cameron and
 Calcasieu Parishes, Louisiana

Based on the subject environmental assessment, I have determined that no significant environmental impacts will result from the proposed action. I request your concurrence in this determination by signing below. Please return this memorandum for our files.

1. I concur. Susan Fruchter 1/10/01
 _____ Date

2. I do not concur.
 _____ Date

Attachments

THE ASSISTANT ADMINISTRATOR
 FOR FISHERIES





UNITED STATES DEPARTMENT OF COMMERCE
 National Oceanic and Atmospheric Administration
 NATIONAL MARINE FISHERIES SERVICE
 Silver Spring, Maryland 20910

DEC 22 2000

MEMORANDUM FOR: F - Penelope D. Dalton
 FROM: F/HC- *Garry F. Mayer*
 SUBJECT: Recommendation of the Issuance of a Finding of No Significant Impact (FONSI) for the Black Bayou Hydrologic Restoration Project, Cameron and Calcasieu Parishes, Louisiana

Under the Coastal Wetlands Planning, Protection, and Restoration Act or CWPPRA (16 U.S.C. §§ 777c, 3951-3956), the U.S. Department of Commerce is part of a multi-agency Task Force responsible for implementing a comprehensive approach to restore and prevent the loss of coastal wetlands in Louisiana. The National Marine Fisheries Service is the Federal sponsor for implementing the CWPPRA-funded Black Bayou Hydrologic Restoration Project (CWPPRA Project No. XCS-48) located in Cameron and Calcasieu Parishes, Louisiana. The Restoration Center (RC) has coordinated the development of engineering plans and anticipates construction to be initiated in 2001.

The RC recently reviewed the final environmental assessment (EA) for the project. The EA now must be formally submitted to the Ecology and Conservation Office for its concurrence.

On the basis of the information presented in the EA for the Black Bayou Hydrologic Restoration Project, the RC believes that no significant impact to the environment will result from the proposed restoration actions.

NOAA Administrative Order 216-6 recommends that the Assistant Administrator make the determination for a FONSI and request the concurrence and clearance of the Office of Ecology and Conservation. I request your concurrence with our recommendation, and the formal submittal of the EA and accompanying documents to the NOAA Office of Ecology and Conservation.

Attachments

I agree *ADD/1/3/01* I disagree _____ Let's discuss _____





UNITED STATES DEPARTMENT OF COMMERCE
Office of the Under Secretary for
Oceans and Atmosphere
Washington, D.C. 20230

JAN 10 2001

TO ALL INTERESTED GOVERNMENT AGENCIES AND PUBLIC GROUPS:

Under the National Environmental Policy Act, an environmental assessment (EA) has been performed on the following action:

TITLE: Black Bayou Hydrologic Restoration Project

LOCATION: Cameron and Calcasieu Parishes, Louisiana

SUMMARY: The Black Bayou Hydrologic Restoration Project, (CWPPRA Project No. XCS-48), is funded under the Coastal Wetlands Planning, Protection, and Restoration Act (16 U.S.C. §§ 777c, 3951-3956). The U.S. Department of Commerce, represented by the National Marine Fisheries Service, is one of five Federal agencies (Task Force) responsible for coordinating projects to restore and prevent the loss of coastal wetlands in Louisiana. The other members of the Task Force are: the U.S. Army Corps of Engineers; the U.S. Environmental Protection Agency; the U.S. Department of Interior, represented by the U.S. Fish and Wildlife Service; the U.S. Department of Agriculture, represented by the Natural Resource Conservation Service; and the State of Louisiana. Thus far, over 100 projects have been authorized by the Task Force. As stipulated by CWPPRA, all projects are funded through a grant or cost-share agreement between the sponsoring Federal agency and the Louisiana Department of Natural Resources. A programmatic environmental impact statement addressing the Louisiana Coastal Wetlands Restoration Plan was prepared by the CWPPRA Task Force and a Record of Decision to proceed with the plan was signed March 18, 1994.

The major goal of CWPPRA is to restore and prevent the loss of coastal wetlands in Louisiana. The purpose of the Black Bayou Hydrologic Restoration Project is to reestablish the natural hydrology of the 27,330 acre project area. Mathematical modeling of water circulation patterns (water levels, flow velocities and directions) and changes in salinity within the modeled area predicts that the completed project will meet the objectives of restoring coastal marsh habitat and slowing the conversion of wetlands to shallow open water areas. The project design will restore 33,800 feet of the southern spoil bank of the Gulf Waterway (GIWW) west of Gum Cove Ridge. A barge bay and two boat bay structures will reduce saltwater intrusion and reduce erosion caused by wave action from boat traffic. A self-regulating steel fixed-crest weir would reduce salt water intrusion and improve aquatic habitat conditions, particularly to marine fisheries.



Printed on Recycled Paper



Without construction, the wetlands habitat loss would continue resulting in a decline of fish and wildlife resources.

RESPONSIBLE

OFFICIAL: Penelope D. Dalton
Assistant Administrator for Fisheries
National Marine Fisheries Service
1315 East-West Highway
Silver Spring, Maryland 20910
301/713-2239

The environmental review process led us to conclude that this action will not have a significant effect on the human environment. Therefore, an environmental impact statement will not be prepared. A copy of the finding of no significant impact including the supporting EA is enclosed for your information. Please submit any written comments to the responsible official named above within 30 calendar days, and to Ramona Schreiber, Office of Policy and Strategic Planning, Room 6117, U.S. Department of Commerce, Herbert Hoover Building, 14th and Constitution Avenue, N.W., Washington, D.C. 20230

Sincerely,

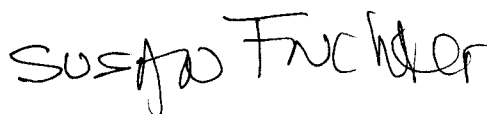

Susan B. Fruchter
NEPA Coordinator
Office of Policy and Strategic
Planning

Enclosure

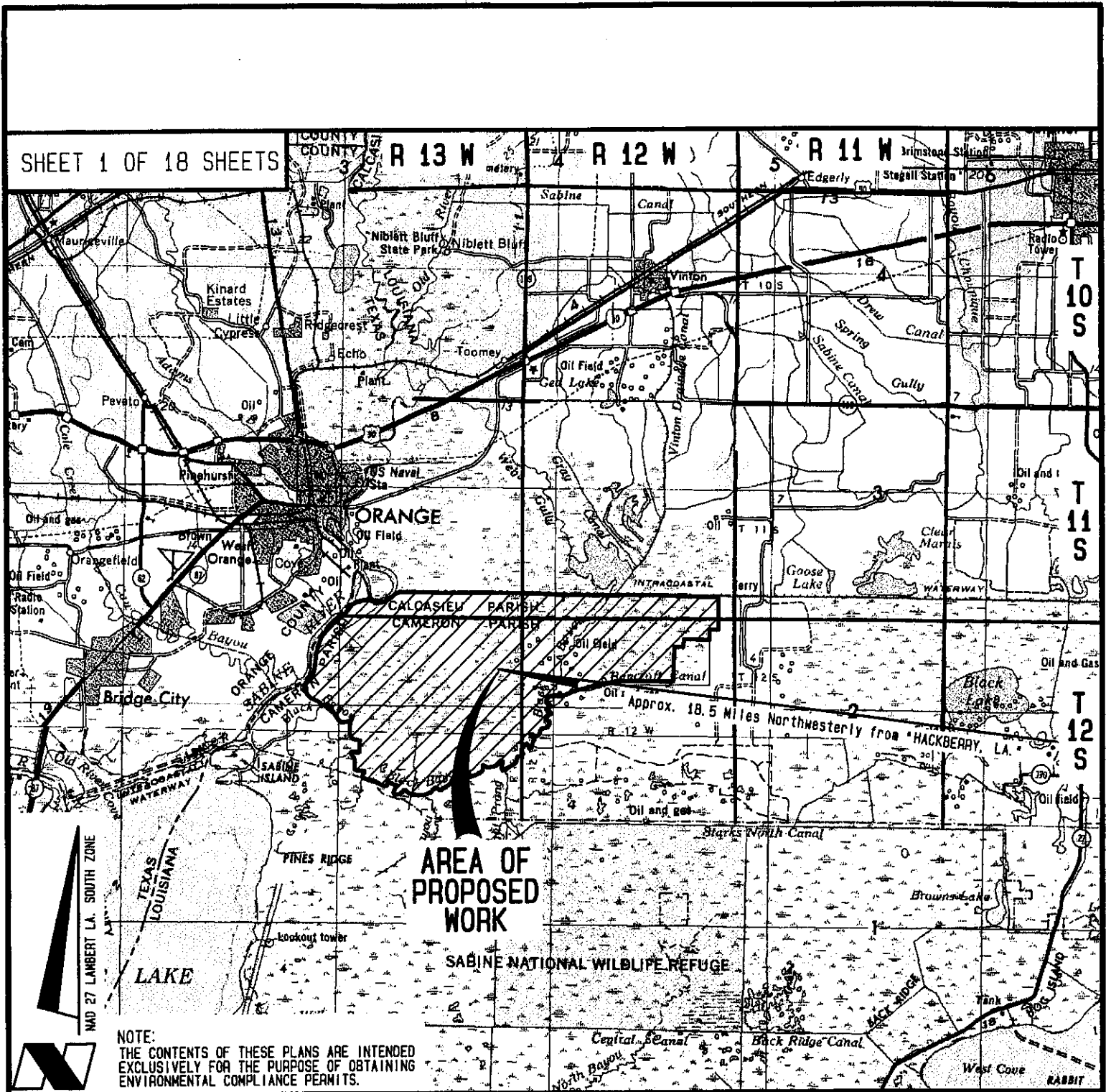

REVISED:

Topography obtained from U.S. Geological Survey Maps
 "LAKE CHARLES, LA.; TX." 1954 Edition, Revised 1972.
 & "PORT ARTHUR, TX.; LA." 1956 Edition, Revised 1973.

VICINITY MAP
 Scale: 1: 250,000

Drawn By: KJP
 Proj. Mgr.: DAD

Application By:
CAMERON PARISH POLICE JURY
 CONSTRUCTED BY:
 LOUISIANA DEPARTMENT OF NATURAL RESOURCES
 (COASTAL RESTORATION DIVISION) & DEPARTMENT
 OF COMMERCE (N.M.F.S.)
 MAY 1, 2000

**BLACK BAYOU HYDROLOGIC
 RESTORATION PROJECT (CS-27)**

T11S-R12W
 Calcasieu Parish, Louisiana
 T12S-R12W & T12S-R13W
 Cameron Parish, Louisiana

995158 I:/infocad/west/IMAGE2 92
 I:/infocad/pcx/LCPA_250

PREPARED BY: C.H. Fenstermaker & Associates, Inc., Lafayette & New Orleans, Louisiana & Houston, Texas.

Figure 1





SCALE 1"=500'

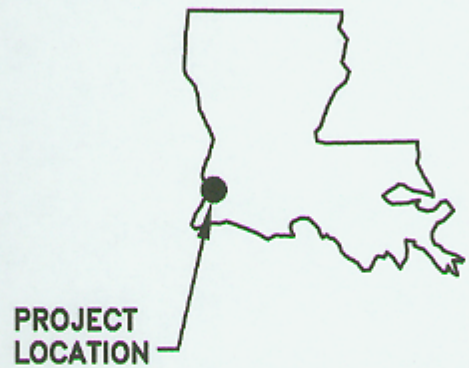

NOTES:

1. Base Image is a 1995 Aerial Infrared Photograph.
2. Total Area = ± 27,328 Ac.

LEGEND:

— BOUNDARY OF HYDROLOGIC PERIMETER

PLANTING SITE

WEIR W/TIDE GATE LOCATION

BLACK BAYOU HYDROLOGIC RESTORATION PROJECT (CS-27)

FIGURE 2

for
National Marine Fisheries Service
N.O.A.A.
U.S. Department of Commerce



G O T E C H , I N C .

CONSULTING ENGINEERS	6363 BLUEBONNET BLVD.	BATON ROUGE, LA. 70810
Date: SEPTEMBER 2000	Job No.: 278	File: LOCATION.dwg
Approved By: MKD	Checked By: MKD	Drawn By: DAB

SHEET 3 OF 18 SHEETS

WATER BOTTOM AFFECTED BY ROCK DIKE 16.1 ACRES
TOTAL MATERIAL REQUIRED FOR ROCK DIKE ±75,180 CU. YDS.

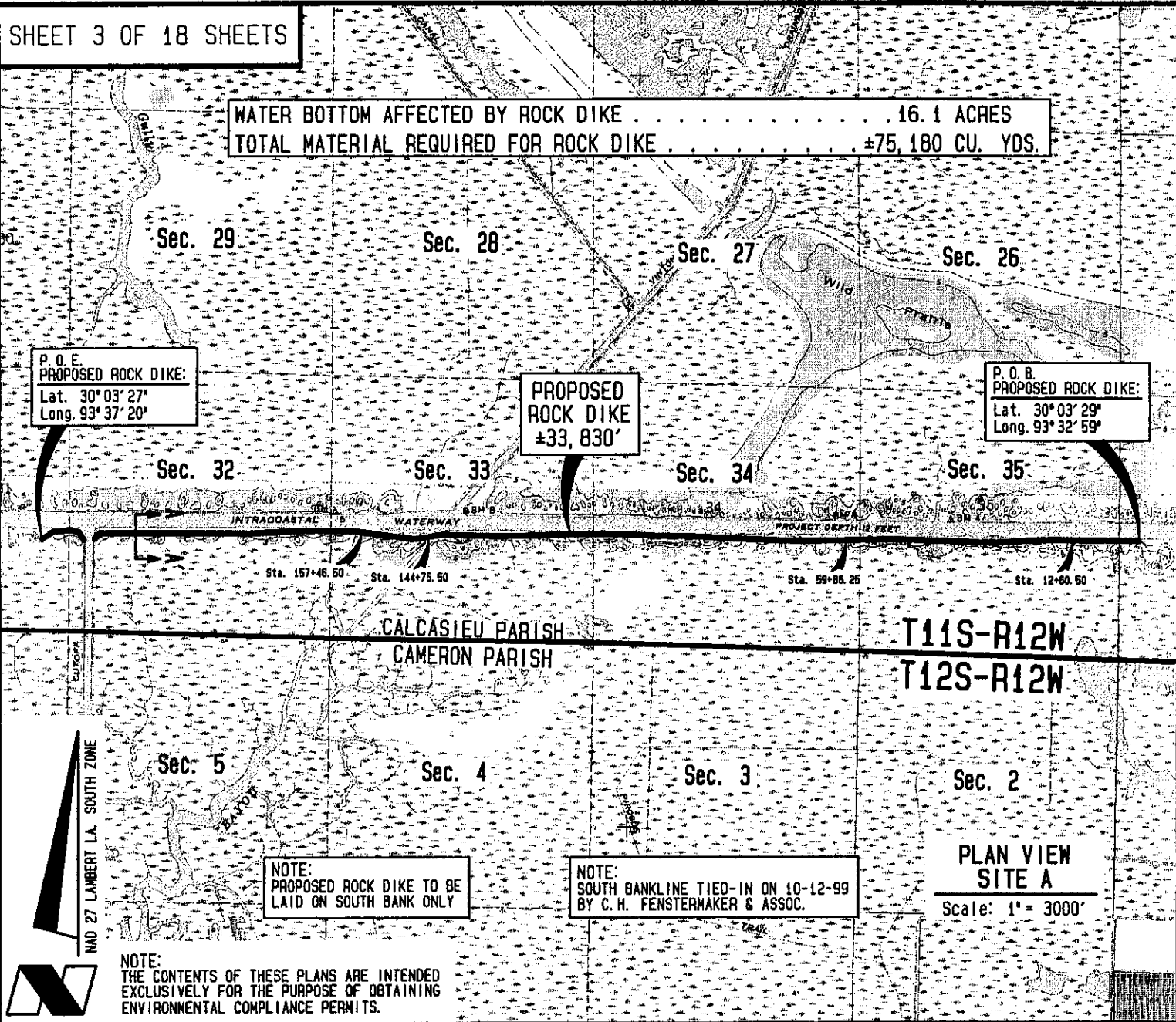

PROPOSED
ROCK DIKE
±33,830'

P.O.E.
PROPOSED ROCK DIKE:
Lat. 30°03'27"
Long. 93°37'20"

P.O.B.
PROPOSED ROCK DIKE:
Lat. 30°03'29"
Long. 93°32'59"

NOTE:
PROPOSED ROCK DIKE TO BE
LAID ON SOUTH BANK ONLY

NOTE:
SOUTH BANKLINE TIED-IN ON 10-12-99
BY C.H. FENSTERMAKER & ASSOC.

PLAN VIEW
SITE A
Scale: 1" = 3000'



NOTE:
THE CONTENTS OF THESE PLANS ARE INTENDED
EXCLUSIVELY FOR THE PURPOSE OF OBTAINING
ENVIRONMENTAL COMPLIANCE PERMITS.

REVISED:

Topography obtained from a Base Map compiled from field survey information (Dated 10-12-99) & digitized information from U.S.G.S. Quadrangle "CAMERON FARMS, LA." 1960 Edition, Revised 1980. and prepared by C.H. Fenstermaker & Associates, Inc.

Application By:
CAMERON PARISH POLICE JURY
CONSTRUCTED BY:
LOUISIANA DEPARTMENT OF NATURAL RESOURCES
(COASTAL RESTORATION DIVISION) & DEPARTMENT
OF COMMERCE (N.M.F.S.)
May 1, 2000

BLACK BAYOU HYDROLOGIC RESTORATION PROJECT (CS-27)

T11S-R12W
Calcasieu Parish, Louisiana
T12S-R12W & T12S-R13W
Cameron Parish, Louisiana

FILE: 995158 I:/infocad/rangew/ 11S12W 31
I:/infocad/pcx/usgs2/30093/CAM_FARM

PREPARED BY: C.H. Fenstermaker & Associates, Inc., Lafayette & New Orleans, Louisiana, & Houston, Texas

Figure 3

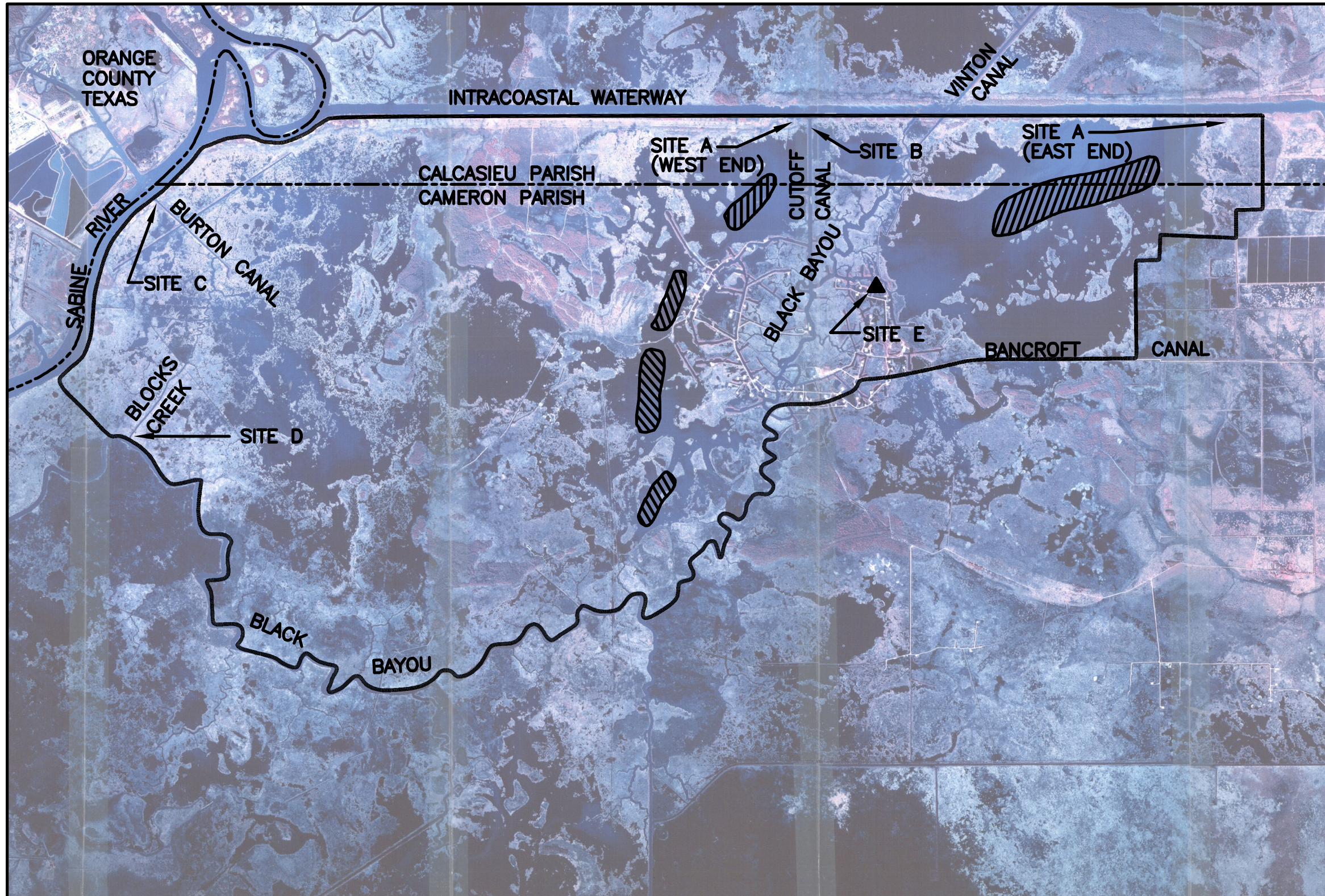

SCALE 1"=5417'

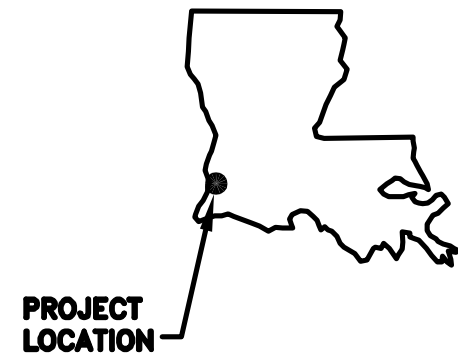

NOTES:

1. Base Image is a 1995 Aerial Infrared Photograph.
2. Total Area = ± 27,328 Ac.

LEGEND:

- BOUNDARY OF HYDROLOGIC PERIMETER
- PLANTING SITE
- WEIR W/TIDE GATE LOCATION

BLACK BAYOU HYDROLOGIC RESTORATION PROJECT (CS-27)

FIGURE 2

**for
National Marine Fisheries Service
N.O.A.A.
U.S. Department of Commerce**



G O T E C H , I N C .

CONSULTING ENGINEERS	8383 BLUEBONNET BLVD.	BATON ROUGE, LA. 70810
Date: SEPTEMBER 2000	Job No.: 278	File: LOCATION.dwg
Approved By: BKD	Checked By: BKD	Drawn By: DAB

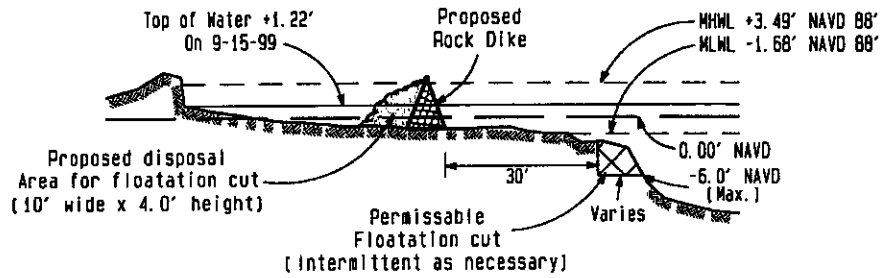
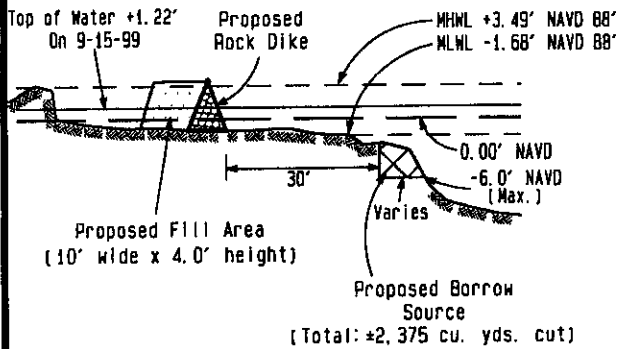
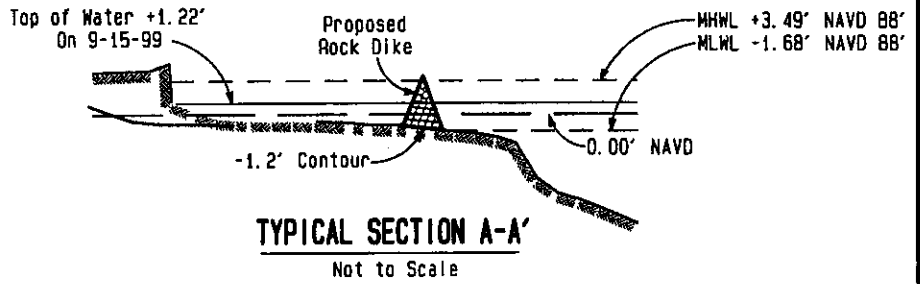

PERMISSIBLE FLOATATION CUT DETAIL
(Intermittent as Necessary)

NOTE:
ROCK DIKE CENTERLINE
TO GENERALLY FOLLOW
-1.2' N. A. V. D. CONTOUR.

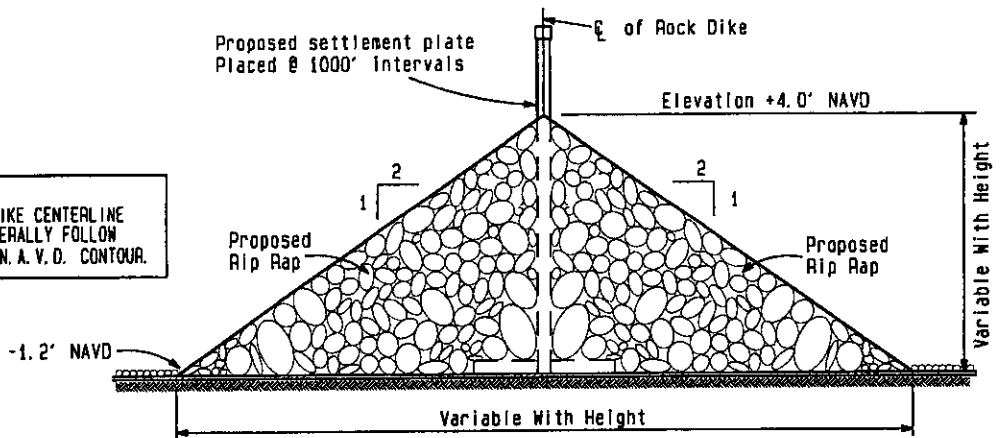

NOTE:
THE CONTENTS OF THESE PLANS ARE INTENDED
EXCLUSIVELY FOR THE PURPOSE OF OBTAINING
ENVIRONMENTAL COMPLIANCE PERMITS.

REVISED:

Application By:
CAMERON PARISH POLICE JURY
CONSTRUCTED BY:
LOUISIANA DEPARTMENT OF NATURAL RESOURCES
(COASTAL RESTORATION DIVISION) & DEPARTMENT
OF COMMERCE (N. M. F. S.)
May 1, 2000

**BLACK BAYOU HYDROLOGIC
RESTORATION PROJECT (CS-27)**

T11S-R12W
Calcasieu Parish, Louisiana
T12S-R12W & T12S-R13W
Cameron Parish, Louisiana

SHEET 5 OF 18 SHEETS

R 12 W

INTRACOASTAL WATERWAY

SEE TYPICAL BANKLINE LINING

BLACK BAYOU CUT OFF CANAL

- Cubic Yards of Rock for Site B: 11,020 cu. yds.
- Total affected open water fill for Site B: 0.40 acres
- Total affected emergent marsh fill for Site B: 0.17 acres

Sec. 31

T 11 S

Existing Monument 'CS-27-2'

Proposed Rock Riprap (±220' x ±10' x ±1')

Proposed Rock Riprap (±250' x ±10' x ±1')

PROPOSED WEIR STRUCTURE WITH BARGE BAY OPENING

Sec. 32

Footprint of Rock Structure

Proposed Rock Riprap (Tie Into Existing Rock Riprap)

Existing Rock Riprap

Proposed Rock Riprap (Tie Into Existing Rock Riprap) (±60' x ±10' x ±1')

Existing Rock Riprap

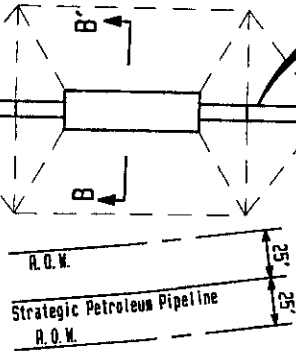

Existing Tide Gauge

SITE B PLAN VIEW

Scale: 1" = 100'

NAD 27 LAMBERT LA. SOUTH ZONE

NOTE: THE CONTENTS OF THESE PLANS ARE INTENDED EXCLUSIVELY FOR THE PURPOSE OF OBTAINING ENVIRONMENTAL COMPLIANCE PERMITS.

●●●●● BANKLINES TIED-IN ON 09/16/99 BY C. H. FENSTERMAKER & ASSOC.

REVISED:

Topography obtained from a Base Map compiled from field survey information (Dated 9-16-99) & prepared by C. H. Fenstermaker & Associates, Inc.

Application By:

CAMERON PARISH POLICE JURY

CONSTRUCTED BY:

LOUISIANA DEPARTMENT OF NATURAL RESOURCES (COASTAL RESTORATION DIVISION) & DEPARTMENT OF COMMERCE (N. M. F. S.)

May 1, 2000

BLACK BAYOU HYDROLOGIC RESTORATION PROJECT (CS-27)

T11S-R12W

Calcasieu Parish, Louisiana

T12S-R12W & T12S-R13W

Cameron Parish, Louisiana

FILE: 995158 i:/infocad/rangew/ 11S12W 32

PREPARED BY: C. H. Fenstermaker & Associates, Inc., Lafayette & New Orleans, Louisiana, & Houston, Texas

Figure 5

SHEET 6 OF 18 SHEETS

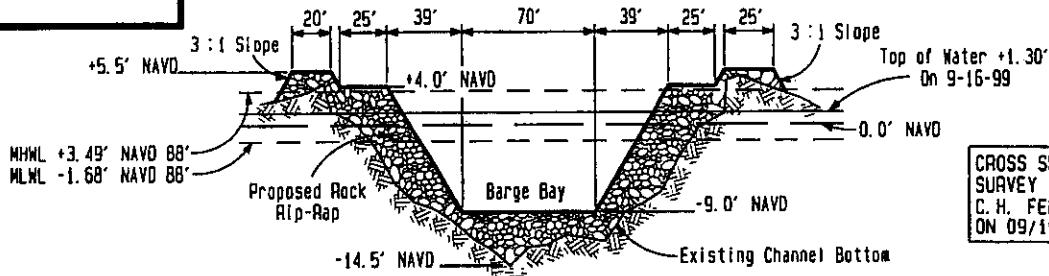

CROSS SECTION DATA BASED ON SURVEY INFORMATION OBTAINED BY C. H. FENSTERMAKER & ASSOCIATES ON 09/16/99.

CROSS SECTION A-A'

Horz. Scale: 1" = 100'
Vert. Scale: 1" = 20'

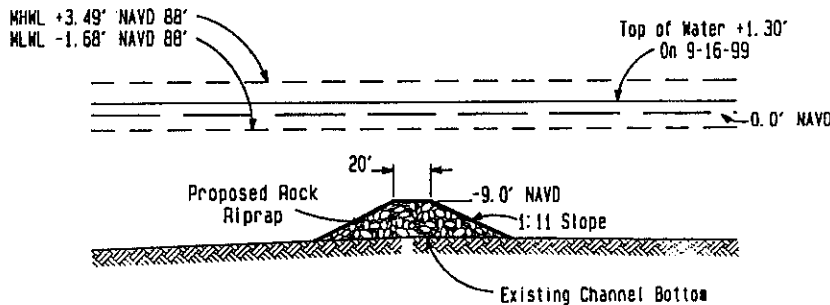

CROSS SECTION DATA BASED ON SURVEY INFORMATION OBTAINED BY C. H. FENSTERMAKER & ASSOCIATES ON 09/16/99.

CROSS SECTION B-B'

Horz. Scale: 1" = 100'
Vert. Scale: 1" = 20'

**SITE B
CROSS-SECTIONS**

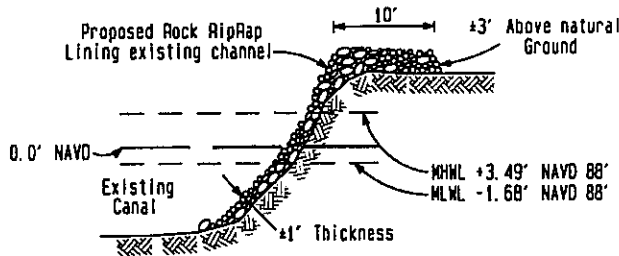

TYPICAL BANKLINE LINING

NOT TO SCALE

CROSS SECTION DATA BASED ON SURVEY INFORMATION OBTAINED BY C. H. FENSTERMAKER & ASSOCIATES ON 09/16/99.

NOTE:
THE CONTENTS OF THESE PLANS ARE INTENDED EXCLUSIVELY FOR THE PURPOSE OF OBTAINING ENVIRONMENTAL COMPLIANCE PERMITS.

REVISED:

Application By:
CAMERON PARISH POLICE JURY
CONSTRUCTED BY:
LOUISIANA DEPARTMENT OF NATURAL RESOURCES
(COASTAL RESTORATION DIVISION) & DEPARTMENT
OF COMMERCE (N. M. F. S.)
May 1, 2000

**BLACK BAYOU HYDROLOGIC
RESTORATION PROJECT (CS-27)**

T11S-R12W
Calcasieu Parish, Louisiana
T12S-R12W & T12S-R13W
Cameron Parish, Louisiana

Figure 6

SHEET 7 OF 18 SHEETS

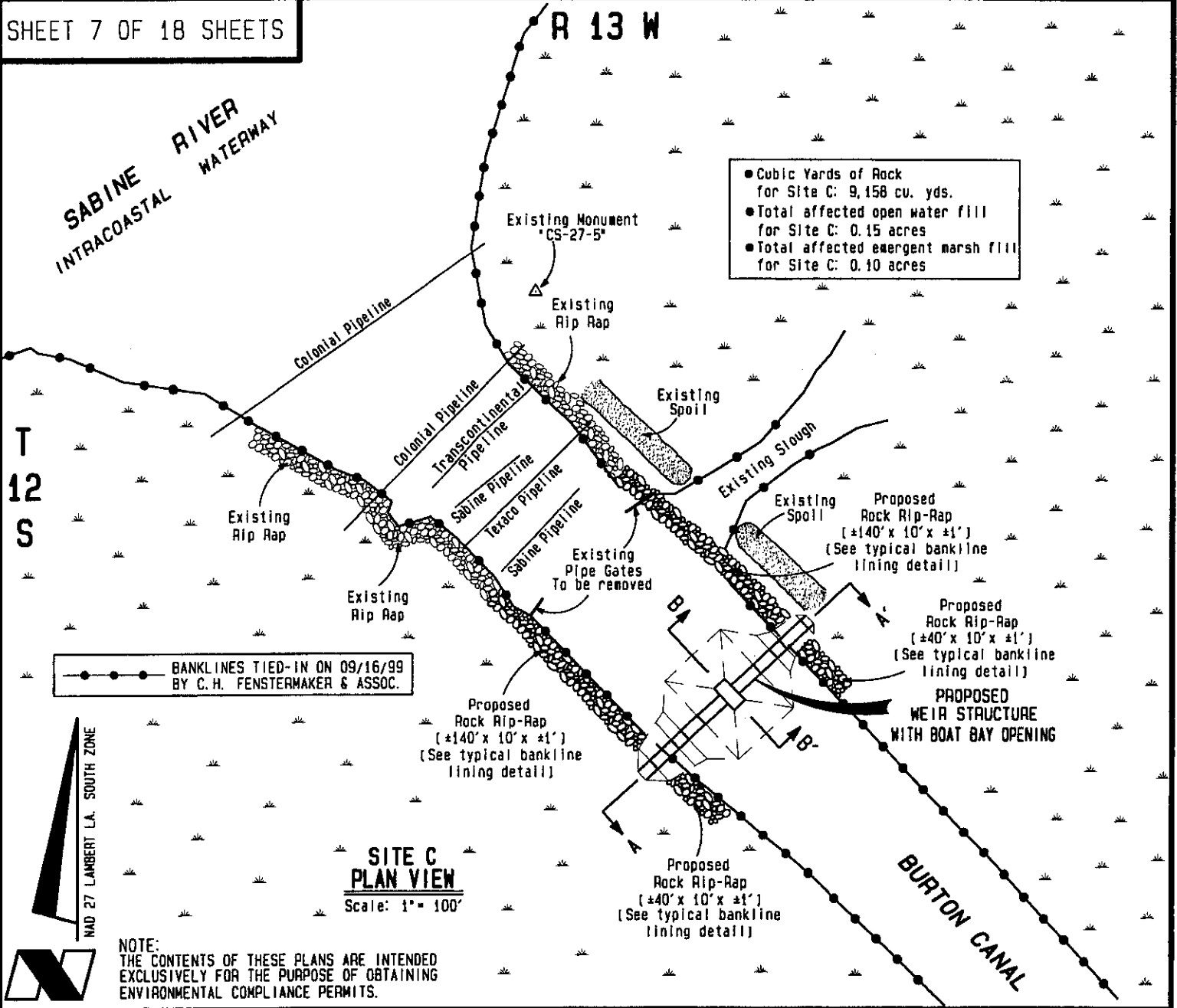

REVISED:

Topography obtained from a Base Map compiled from field survey information (Dated 9-16-99) & prepared by C.H. Fenstermaker & Associates, Inc.

Application By:
CAMERON PARISH POLICE JURY
CONSTRUCTED BY:
LOUISIANA DEPARTMENT OF NATURAL RESOURCES
(COASTAL RESTORATION DIVISION) & DEPARTMENT
OF COMMERCE (N.M.F.S.)
May 1, 2000

BLACK BAYOU HYDROLOGIC RESTORATION PROJECT (CS-27)

T11S-R12W
Calcasieu Parish, Louisiana
T12S-R12W & T12S-R13W
Cameron Parish, Louisiana

Figure 7

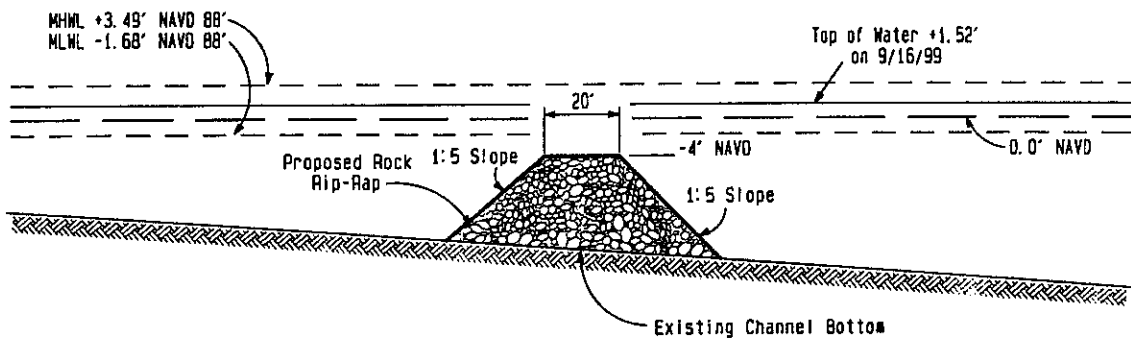
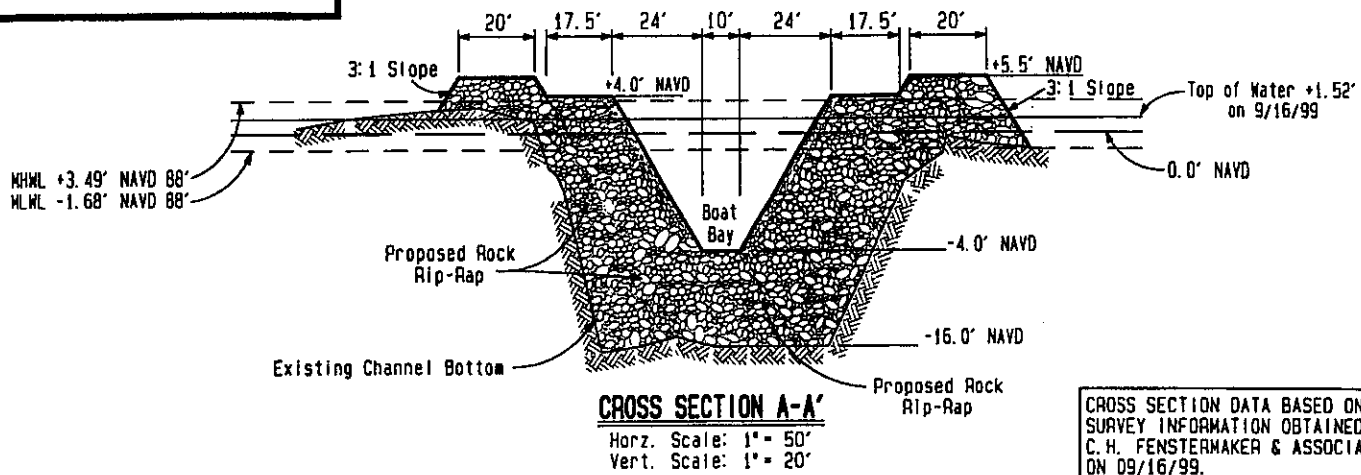

**SITE C
CROSS-SECTIONS**

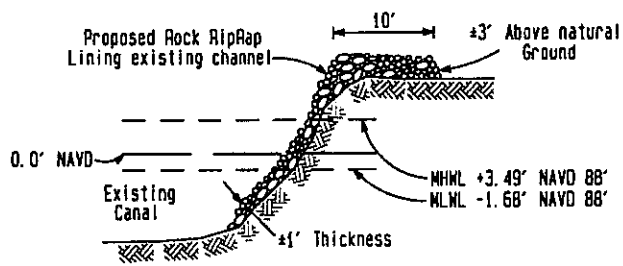

TYPICAL BANKLINE LINING
NOT TO SCALE

NOTE:
THE CONTENTS OF THESE PLANS ARE INTENDED
EXCLUSIVELY FOR THE PURPOSE OF OBTAINING
ENVIRONMENTAL COMPLIANCE PERMITS.

REVISED:

Application By:
CAMERON PARISH POLICE JURY
CONSTRUCTED BY:
LOUISIANA DEPARTMENT OF NATURAL RESOURCES
(COASTAL RESTORATION DIVISION) & DEPARTMENT
OF COMMERCE (N. M. F. S.)
May 1, 2000

**BLACK BAYOU HYDROLOGIC
RESTORATION PROJECT (CS-27)**

T11S-R12W
Calcasieu Parish, Louisiana
T12S-R12W & T12S-R13W
Cameron Parish, Louisiana

Figure 8

SHEET 9 OF 18 SHEETS

R 13 W

BANKLINES TIED-IN ON 09/22/99
BY C. H. FENSTERMAKER & ASSOC.

BLOCK'S CREEK

- Cubic Yards of Rock for Site D: 3,603 cu. yds.
- Total affected open water fill for Site D: 0.05 acres
- Total affected emergent marsh fill for Site D: 0.07 acres

Proposed Rock RipRap
(±40' x 10' x ±1')
(See typical bankline lining detail)

Proposed Rock RipRap
(±40' x 10' x ±1')
(See typical bankline lining detail)

Proposed Rock RipRap
(±40' x 10' x ±1')
(See typical bankline lining detail)

Footprint of Rock Structure

PROPOSED WEIR STRUCTURE WITH BOAT BAY OPENING

Proposed Rock RipRap
(±40' x 10' x ±1')
(See typical bankline lining detail)

Existing Monument 'CS-27-6'

BLACK BAYOU

**SITE D
PLAN VIEW**
Scale: 1" = 100'

T
12
S



NOTE:
THE CONTENTS OF THESE PLANS ARE INTENDED EXCLUSIVELY FOR THE PURPOSE OF OBTAINING ENVIRONMENTAL COMPLIANCE PERMITS.

REVISED:

Topography obtained from a Base Map compiled from field survey information (Dated 9-22-99) & prepared by C. H. Fenstermaker & Associates, Inc.

Application By:
CAMERON PARISH POLICE JURY
CONSTRUCTED BY:
LOUISIANA DEPARTMENT OF NATURAL RESOURCES
(COASTAL RESTORATION DIVISION) & DEPARTMENT OF COMMERCE (N. M. F. S.)
May 1, 2000

BLACK BAYOU HYDROLOGIC RESTORATION PROJECT (CS-27)

T11S-R12W
Calcasieu Parish, Louisiana
T12S-R12W & T12S-R13W
Cameron Parish, Louisiana

Figure 9

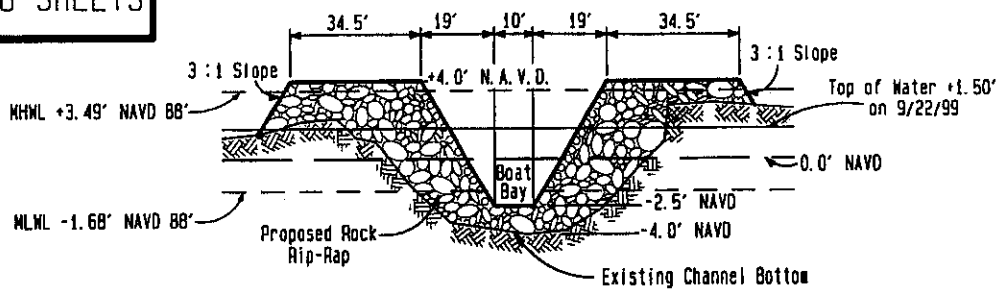

CROSS SECTION A-A'

Horz. Scale: 1" = 50'
Vert. Scale: 1" = 10'

CROSS SECTION DATA BASED ON SURVEY INFORMATION OBTAINED BY C. H. FENSTERMAKER & ASSOCIATES ON 09/22/99.

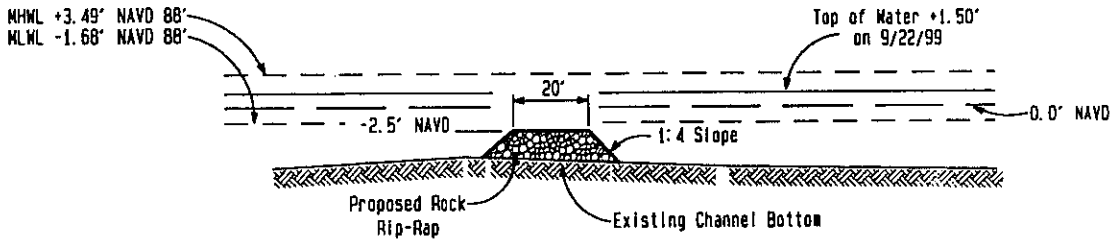

CROSS SECTION B-B'

Horz. Scale: 1" = 50'
Vert. Scale: 1" = 20'

CROSS SECTION DATA BASED ON SURVEY INFORMATION OBTAINED BY C. H. FENSTERMAKER & ASSOCIATES ON 09/22/99.

**SITE D
CROSS-SECTIONS**

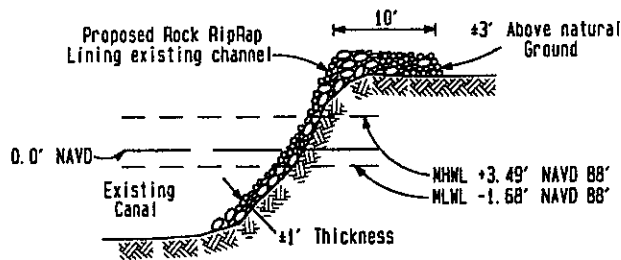

TYPICAL BANKLINE LINING

NOT TO SCALE

NOTE:
THE CONTENTS OF THESE PLANS ARE INTENDED EXCLUSIVELY FOR THE PURPOSE OF OBTAINING ENVIRONMENTAL COMPLIANCE PERMITS.

REVISED:

Application By:
CAMERON PARISH POLICE JURY
CONSTRUCTED BY:
LOUISIANA DEPARTMENT OF NATURAL RESOURCES
(COASTAL RESTORATION DIVISION) & DEPARTMENT
OF COMMERCE (N. M. F. S.)
May 1, 2000

**BLACK BAYOU HYDROLOGIC
RESTORATION PROJECT (CS-27)**

T11S-R12W
Calcasieu Parish, Louisiana
T12S-R12W & T12S-R13W
Cameron Parish, Louisiana

SHEET 11 OF 18 SHEETS

R 12 W

- Total cubic yards of Rock for Site E: 3,280 cu. yds.
- Total affected open water fill for Site E: 0.80 acres
- Total affected emergent marsh fill for Site E: 0.10 acres
- Total affected open water excavation for Site E: 0.44 acres
- Total affected levee excavation for Site E: 0.13 acres
- Total excavation for Site E: 3,695 cu. yds.

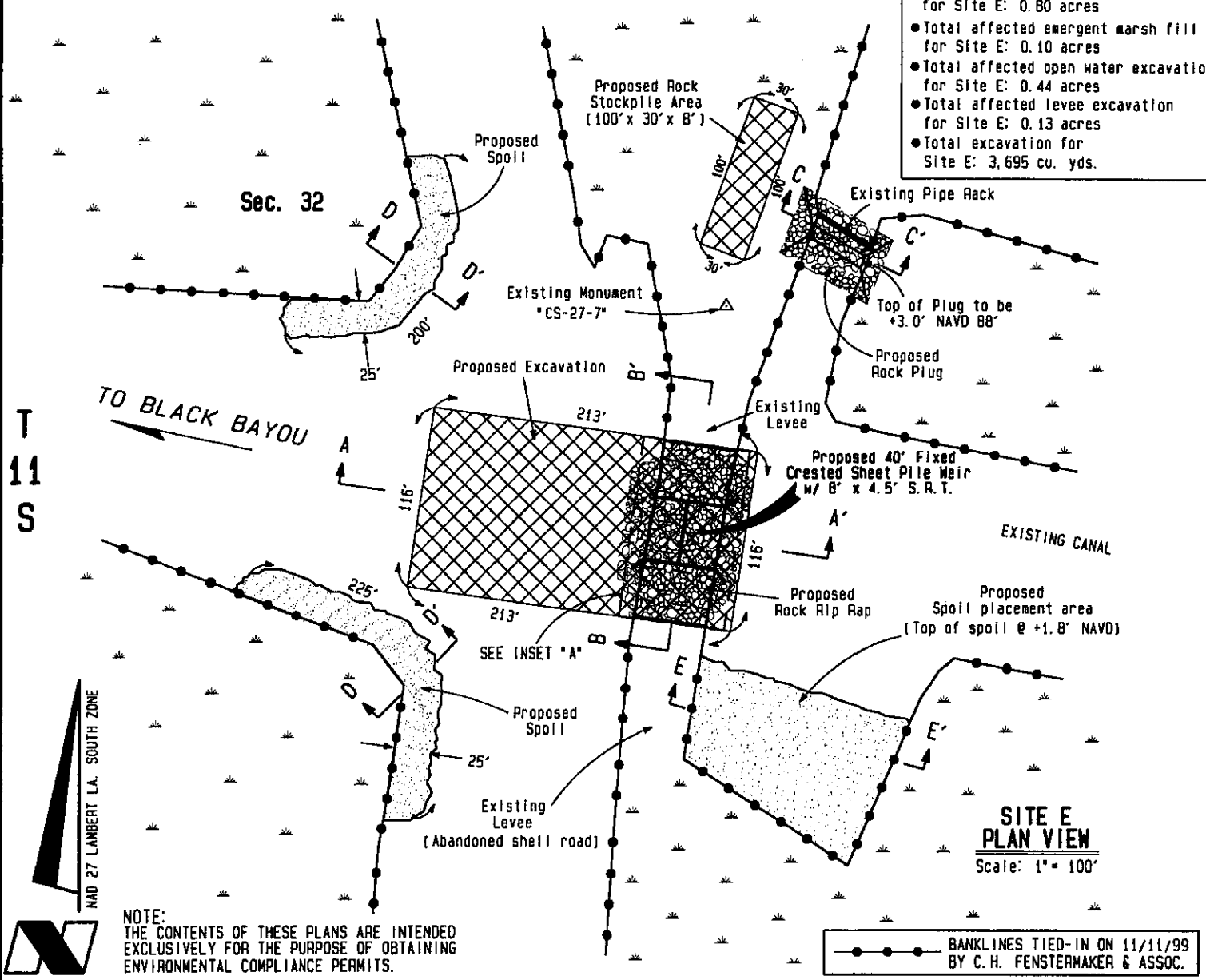

NOTE:
 THE CONTENTS OF THESE PLANS ARE INTENDED EXCLUSIVELY FOR THE PURPOSE OF OBTAINING ENVIRONMENTAL COMPLIANCE PERMITS.

●●●●● BANKLINES TIED-IN ON 11/11/99 BY C. H. FENSTERMAKER & ASSOC.

REVISED:

Topography obtained from a Base Map compiled from field survey information (Dated 11-11-99) & prepared by C. H. Fenstermaker & Associates, Inc.

Application By:
CAMERON PARISH POLICE JURY
 CONSTRUCTED BY:
 LOUISIANA DEPARTMENT OF NATURAL RESOURCES
 (COASTAL RESTORATION DIVISION) & DEPARTMENT
 OF COMMERCE (N. M. F. S.)
 May 1, 2000

BLACK BAYOU HYDROLOGIC RESTORATION PROJECT (CS-27)

T11S-R12W
 Calcasieu Parish, Louisiana
 T12S-R12W & T12S-R13W
 Cameron Parish, Louisiana

Figure 11

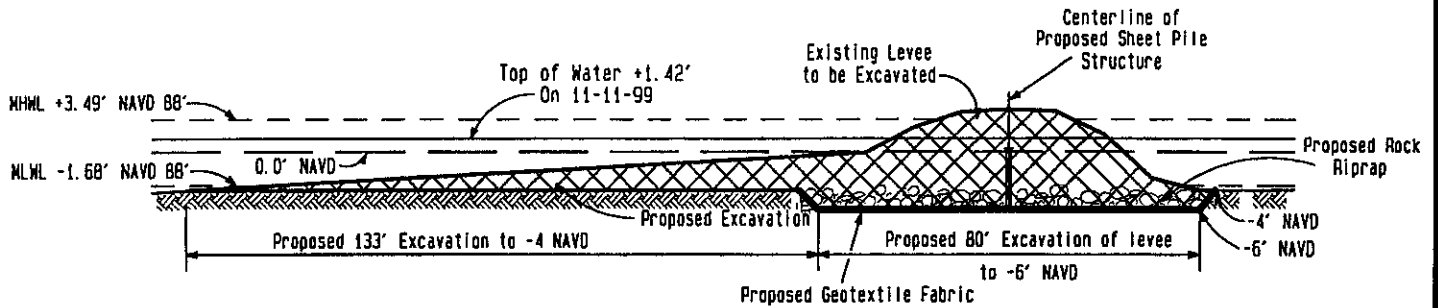
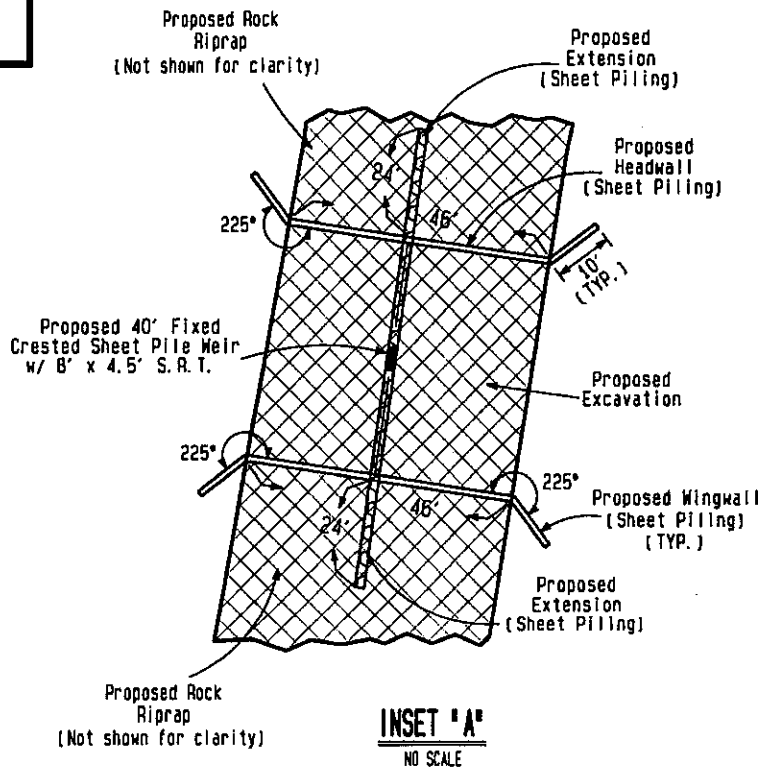

NOTE:
THE CONTENTS OF THESE PLANS ARE INTENDED EXCLUSIVELY FOR THE PURPOSE OF OBTAINING ENVIRONMENTAL COMPLIANCE PERMITS.

CROSS SECTION A-A'

Horz. Scale: 1" = 40'
Vert. Scale: 1" = 20'

CROSS SECTION DATA BASED ON SURVEY INFORMATION OBTAINED BY C. H. FENSTERMAKER & ASSOCIATES ON 11/11/99.

**SITE E
CROSS-SECTIONS**

REVISED:

Application By:
CAMERON PARISH POLICE JURY
CONSTRUCTED BY:
LOUISIANA DEPARTMENT OF NATURAL RESOURCES
(COASTAL RESTORATION DIVISION) & DEPARTMENT
OF COMMERCE (N. M. F. S.)
May 1, 2000

**BLACK BAYOU HYDROLOGIC
RESTORATION PROJECT (CS-27)**

T11S-R12W
Calcasieu Parish, Louisiana
T12S-R12W & T12S-R13W
Cameron Parish, Louisiana

Figure 12

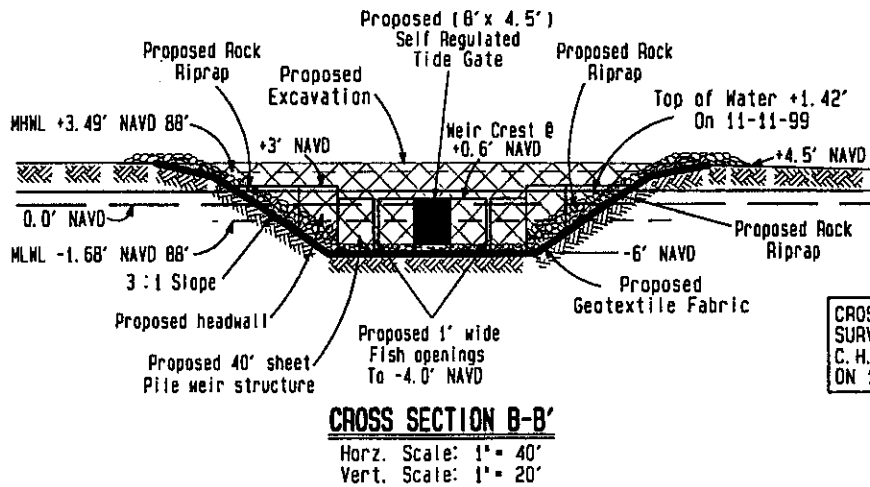

CROSS SECTION DATA BASED ON SURVEY INFORMATION OBTAINED BY C. H. FENSTERMAKER & ASSOCIATES ON 11/11/99.

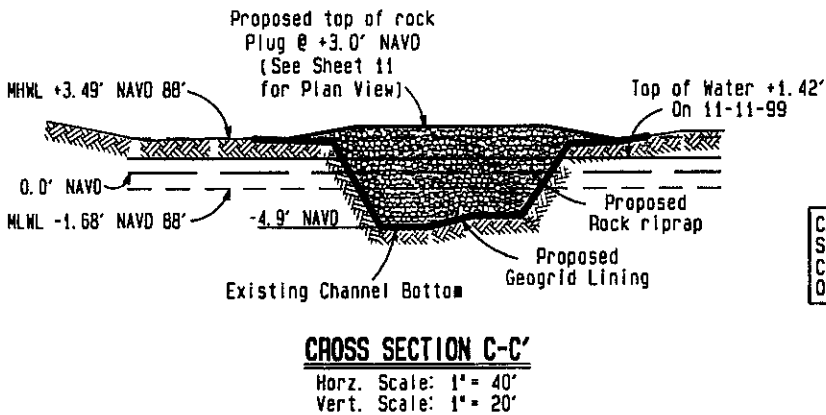

CROSS SECTION DATA BASED ON SURVEY INFORMATION OBTAINED BY C. H. FENSTERMAKER & ASSOCIATES ON 11/11/99.

**SITE E
 CROSS-SECTIONS**

NOTE:
 THE CONTENTS OF THESE PLANS ARE INTENDED EXCLUSIVELY FOR THE PURPOSE OF OBTAINING ENVIRONMENTAL COMPLIANCE PERMITS.

REVISED:

Application By:
CAMERON PARISH POLICE JURY
 CONSTRUCTED BY:
 LOUISIANA DEPARTMENT OF NATURAL RESOURCES
 (COASTAL RESTORATION DIVISION) & DEPARTMENT
 OF COMMERCE (N. M. F. S.)
 May 1, 2000

**BLACK BAYOU HYDROLOGIC
 RESTORATION PROJECT (CS-27)**

T11S-R12W
 Calcasieu Parish, Louisiana
 T12S-R12W & T12S-R13W
 Cameron Parish, Louisiana

Figure 13

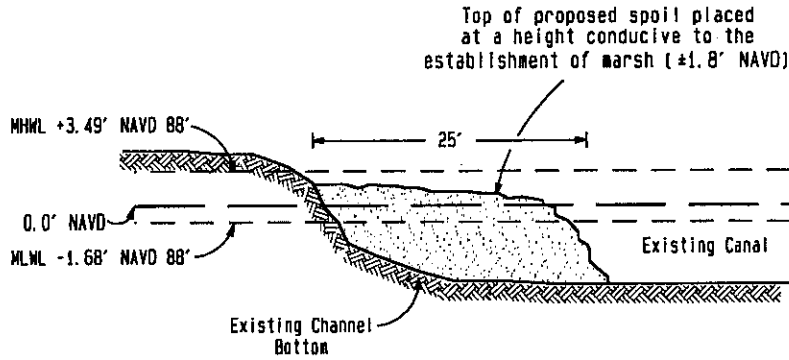

CROSS SECTION D-D'
Not to Scale

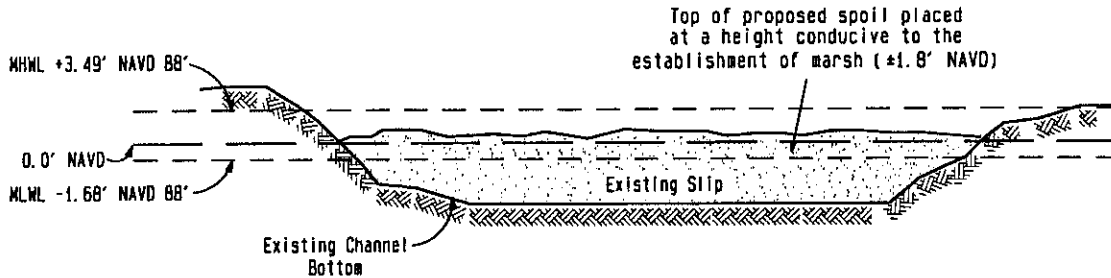

CROSS SECTION E-E'
Not to Scale

NOTE:
THE CONTENTS OF THESE PLANS ARE INTENDED EXCLUSIVELY FOR THE PURPOSE OF OBTAINING ENVIRONMENTAL COMPLIANCE PERMITS.

REVISED:

Application By:
CAMERON PARISH POLICE JURY
CONSTRUCTED BY:
LOUISIANA DEPARTMENT OF NATURAL RESOURCES
(COASTAL RESTORATION DIVISION) & DEPARTMENT
OF COMMERCE (N. M. F. S.)
May 1, 2000

**BLACK BAYOU HYDROLOGIC
RESTORATION PROJECT (CS-27)**

T11S-R12W
Calcasieu Parish, Louisiana
T12S-R12W & T12S-R13W
Cameron Parish, Louisiana

- Cubic Yards of Excavation for Site E access: 17,958 cu. yds.
- Total affected acreage from open water dredging for Site E access: 3.81 acres
- Total affected acreage from spoil placement for Site E access: 3.33 acres

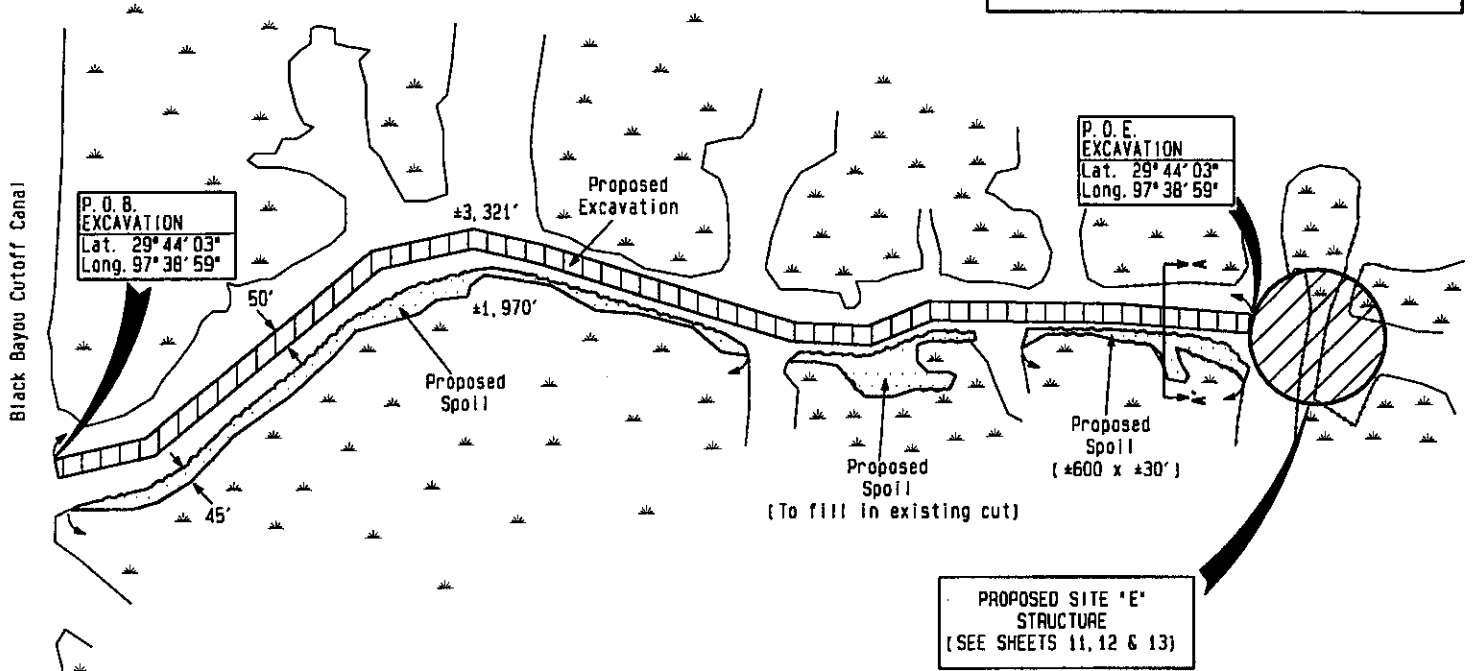

**SITE E
PERMISSIBLE ACCESS CUT
PLAN VIEW**
Scale: 1" = 500'

General Note:
Proposed spoil to be placed only in open water areas conducive to the establishment of marsh.

NOTE:
THE CONTENTS OF THESE PLANS ARE INTENDED EXCLUSIVELY FOR THE PURPOSE OF OBTAINING ENVIRONMENTAL COMPLIANCE PERMITS.

BANKLINES TIED-IN ON 11/11/99
BY C.H. FENSTERMAKER & ASSOC.

REVISED:

Topography obtained from a Base Map compiled from field survey information (Dated 11-11-99) & prepared by C.H. Fenstermaker & Associates, Inc.

Application By:
CAMERON PARISH POLICE JURY
CONSTRUCTED BY:
LOUISIANA DEPARTMENT OF NATURAL RESOURCES
(COASTAL RESTORATION DIVISION) & DEPARTMENT
OF COMMERCE (N.M.F.S.)
May 1, 2000

**BLACK BAYOU HYDROLOGIC
RESTORATION PROJECT (CS-27)**

T11S-R12W
Calcasieu Parish, Louisiana
T12S-R12W & T12S-R13W
Cameron Parish, Louisiana

Figure 15

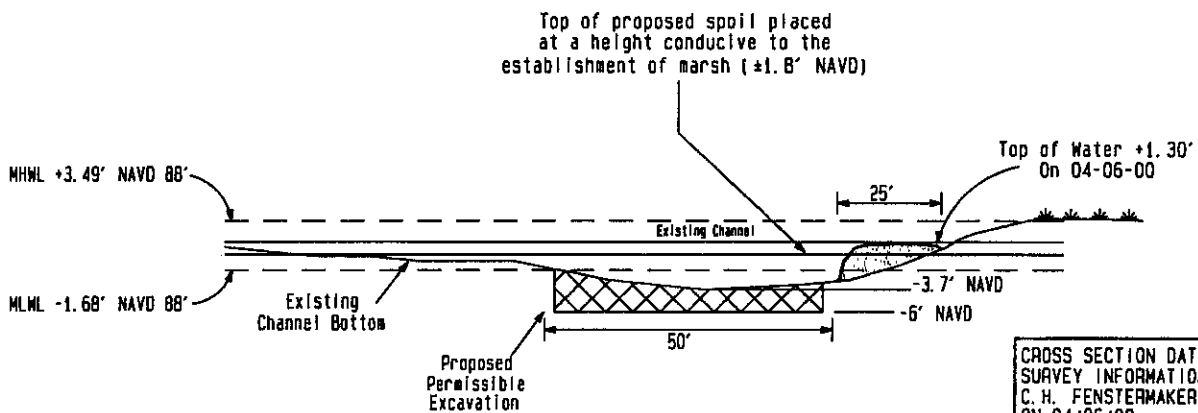

CROSS SECTION DATA BASED ON SURVEY INFORMATION OBTAINED BY C. H. FENSTERMAKER & ASSOCIATES ON 04/06/00.

CROSS SECTION A-A'

Horz. Scale: 1" = 40'
Vert. Scale: 1" = 20'

NOTE:
THE CONTENTS OF THESE PLANS ARE INTENDED EXCLUSIVELY FOR THE PURPOSE OF OBTAINING ENVIRONMENTAL COMPLIANCE PERMITS.

REVISED:

Application By:
CAMERON PARISH POLICE JURY
CONSTRUCTED BY:
LOUISIANA DEPARTMENT OF NATURAL RESOURCES
(COASTAL RESTORATION DIVISION) & DEPARTMENT
OF COMMERCE (N. M. F. S.)
May 1, 2000

**BLACK BAYOU HYDROLOGIC
RESTORATION PROJECT (CS-27)**

T11S-R12W
Calcasieu Parish, Louisiana
T12S-R12W & T12S-R13W
Cameron Parish, Louisiana

Figure 16

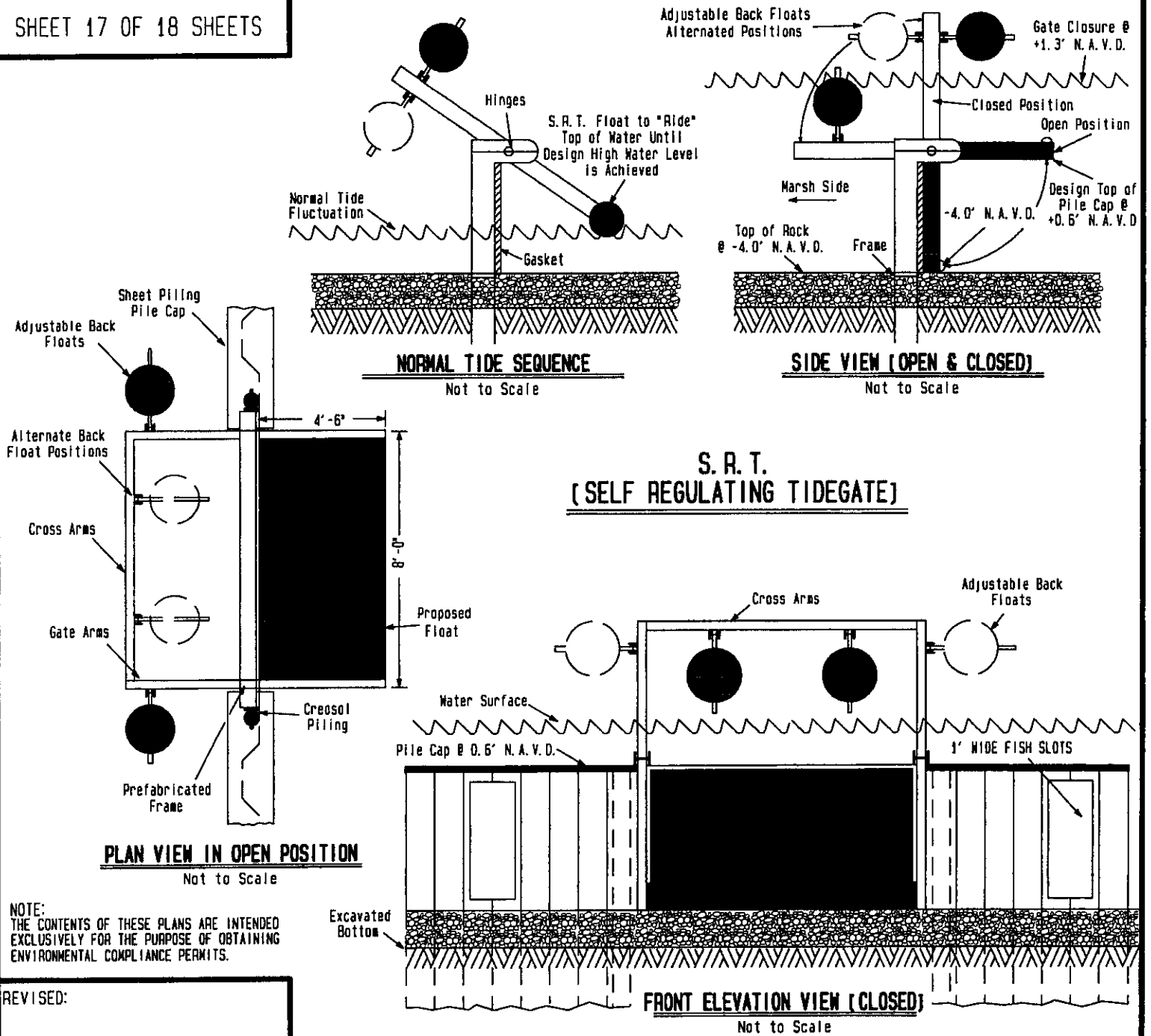

Application By:
CAMERON PARISH POLICE JURY
 CONSTRUCTED BY:
 LOUISIANA DEPARTMENT OF NATURAL RESOURCES
 (COASTAL RESTORATION DIVISION) & DEPARTMENT
 OF COMMERCE (N. M. F. S.)
 May 1, 2000

**BLACK BAYOU HYDROLOGIC
 RESTORATION PROJECT (CS-27)**

T11S-R12W
 Calcasieu Parish, Louisiana
 T12S-R12W & T12S-R13W
 Cameron Parish, Louisiana

Figure 17

OPERATION OF THE SELF REGULATING TIDEGATE

The buoyant S.R.T. (Self Regulating Tidegate) is a prefabricated mechanical gate which is totally operated by itself. The S.R.T. is hinged on the top of the proposed fixed crested sheet pile weir so that it floats on the surface of the water until closed by counter floats extending above and behind the hinge point. The position of the counter floats on the arms is adjusted to meet the required gate closure water level (+1.3' N.A.V.D.). Once the predetermined high water level is achieved, the S.R.T. automatically closes and stays closed during the flood event, thereby protecting the "impoundment area" from tidal surge and salt water intrusion. Once the tide recedes on the outside of the "impoundment area", the hydraulic head reverses through the weir and the S.R.T. automatically reopens thereby allowing normal inflow and outflow through the proposed fixed crested sheet pile weir structure.

NOTES:

1. In order to insure the safety of all parties, the permittee shall contact the Louisiana ONE CALL System (1-800-272-3020), a minimum of 48 hours prior to the commencement of any excavation (Digging, Dredging, Jetting, etc.) or demolition activity.
2. Structures will also be marked/lighted in accordance with U. S. Coast Guard regulations.

NOTE:
THE CONTENTS OF THESE PLANS ARE INTENDED
EXCLUSIVELY FOR THE PURPOSE OF OBTAINING
ENVIRONMENTAL COMPLIANCE PERMITS.

REVISED:

Application By:
CAMERON PARISH POLICE JURY
CONSTRUCTED BY:
LOUISIANA DEPARTMENT OF NATURAL RESOURCES
(COASTAL RESTORATION DIVISION) & DEPARTMENT
OF COMMERCE (N. M. F. S.)
May 1, 2000

BLACK BAYOU HYDROLOGIC RESTORATION PROJECT (CS-27)

T11S-R12W
Calcasieu Parish, Louisiana
T12S-R12W & T12S-R13W
Cameron Parish, Louisiana

LITERATURE CITED

- Barras, J.A., P.E Bourgeois, and L.R. Handley. 1994. Land loss in coastal Louisiana 1956-90. National Biological Survey, National Wetlands Research Center, Open File Report 94-01.
- Bellrose, F.C. 1976. Ducks, Geese, and Swans of North America. Stackpole Books, Harrisburg, Pennsylvania.
- Boesch, D.F., and N.N. Rabalais, ed. 1989. Produced waters in Sensitive Coastal Habitats: An Analysis of Impacts, Central Coastal Gulf of Mexico. OCS Report/MMS 89-0031. U.S. Department of Interior, Minerals Management Service, Gulf of Mexico OCS Regional Office, New Orleans, Louisiana.
- Boesch, D.F., and R.E. Turner. 1984. Dependence on fishery species on salt marshes: the role of food and refuge. *Estuaries*. 7:460-468.
- Buckley, J. 1984. Habitat suitability index models: larval and juvenile red drum. U.S. Fish and Wildlife Service. FWS/OBS-82/10.74. 15 pp.
- C.H. Fenstermaker & Associates, Inc. 1999 and 2000. Preliminary Engineering Design Report for Black Bayou Hydrologic Restoration Project (CS-27). Engineering Design Contract No. 2511-99-19. Prepared for Louisiana Department of Natural Resources and National Marine Fisheries Service. Lafayette, Louisiana. 7 pp.
- Chabreck, R. H., and G. Linscombe. 1968, 1978, and 1988. Vegetative Type Map of the Louisiana Coastal Marshes. Louisiana Department of Wildlife and Fisheries, New Orleans, Louisiana.
- Chabreck, R. H., G. Linscombe, S. Hartley, J. Johnston, and A. Martucci. 1997. Louisiana Coastal Marsh Vegetative Type GIS CD. Louisiana Department of Wildlife and Fisheries, New Orleans, Louisiana, USGS National Wetlands Research Center, Lafayette, LA.
- Coleman, J.M. 1988. Dynamic changes and processes in the Mississippi River delta. *Geological Society of America Bulletin* 100:999-1015.
- Condrey, R., P. Kemp, J. Visser, J. Gosselink, D. Lindstedt, E. Melancon, G. Peterson, and B. Thompson. 1995. Status, Trends, and Probable Causes of Change in Living Resources in the Barataria and Terrebonne Estuarine Systems. BTNEP Publ. No. 21, Barataria-Terrebonne National Estuary Program, Thibodaux, Louisiana, 434 pp.
- Deegan, L.A., B.J. Peterson, and R. Potier. 1990. Stable isotopes and cellulase activity as evidence for detritus as a food source for juvenile Gulf Menhaden. *Estuaries*. 13:14-19.

- Dundee, H.A., and D.A. Rossman. 1989. *The Amphibians and Reptiles of Louisiana*. Louisiana State University Press. Baton Rouge and London. 300 pp.
- Frazier, J.G. 1980. Marine turtles and problems in coastal management, pp. 2395-2411. *In* B.L. Edge (ed.). *Coastal Zone 80: Proceedings of the Second Symposium on Coastal and Ocean Management*. American Society of Engineers, New York.
- Fisk, H.N. 1944. Geological investigations of the alluvial valley of the lower Mississippi River. U.S. Army Corps of Engineers Report, Mississippi River Commission, 78p.
- Gagliano, S.M., and J.L. Van Beek. 1970. Geologic and geomorphic aspects of deltaic processes: Mississippi delta system. Center for Wetland Resources, Louisiana State University, Baton Rouge. *Hydrologic and Geologic Studies of Coastal Louisiana* no 1.
- Gosselink, J.G., C.L. Cordes and J.W. Parsons. 1979. *An Ecological Characterization Study of the Chenier Plain Coastal Ecosystem of Louisiana and Texas*. 3 vol. U.S. Fish and Wildlife Service, Office of Biological Services. FWS/OBS-78/9 through 78-11.
- Gould, H.R., and E. McFarlan, Jr. 1959. Geologic history of the Chenier Plain, southwestern Louisiana. *Transactions of the Gulf Coast Association of Geologists Society* 9:261-270.
- Gulf of Mexico Fishery Management Council. 1998. Generic amendment for addressing essential fish habitat requirements in the following fishery management plans of the Gulf of Mexico: Shrimp Fishery of the Gulf of Mexico, United States Waters, Red Drum Fishery of the Gulf of Mexico, Reef Fish Fishery of the Gulf of Mexico, Coastal Migratory Pelagic Resources (Mackerels) in the Gulf of Mexico and South Atlantic, Stone Crab Fishery of the Gulf of Mexico, Spiny Lobster in the Gulf of Mexico and South Atlantic, Coral and Coral Reefs of the Gulf of Mexico.
- Herke, W.H. 1978. Some effects of semi-impoundment on coastal Louisiana fish and crustacean nursery usage, p. 325-346. *In* R.H. Chabreck (ed.). *Proceedings of the Third Coastal Marsh and Estuary Management Symposium*. Division of Continuing Education, Louisiana State University, Baton Rouge, Louisiana.
- Hoese, H.D. 1976. *Final Report: Study of Sport and Commercial Fishes of the Atchafalaya Bay Region*. Conducted for the U.S. Fish and Wildlife Service by the Department of Biology, University of Southwestern Louisiana, Lafayette, Louisiana. 54 pp.
- Lassuy, D.R. 1983. *Species profiles: life histories and environmental requirements (Gulf of Mexico) – brown shrimp*. U.S. Fish and Wildlife Service, Division of Biological Services. FWS/OBS-82/11.1. U.S. Army Corps of Engineers, TR EL-82-4. 15 pp.

- Linscombe, G., and N. Kinler. 1985. Fur harvest distribution in coastal Louisiana, p.187-199. In C.F. Bryan, P.J. Zwank and R.N. Chabreck (eds.). Proceedings of the Fourth Coastal Marsh and Estuary Management Symposium. Louisiana Cooperative Fishery Research Unit, Louisiana State University Agricultural Center, Baton Rouge, Louisiana.
- Louisiana Coastal Wetlands Conservation and Restoration Task Force. 1993a. Louisiana Coastal Wetlands Restoration Plan. Calcasieu/Sabine Basin. Appendix 1. 236 pp.
- Louisiana Coastal Wetlands Conservation and Restoration Task Force. 1993b. Louisiana Coastal Wetlands Restoration Plan: Main Report and Environmental Impact Statement.
- Louisiana Coastal Wetlands Conservation and Restoration Task Force. 1997. Sixth Priority Project List Report. 67 pp. plus plates and appendices.
- Louisiana Coastal Wetlands Conservation and Restoration Task Force and the Wetlands Conservation and Restoration Authority. 1998. Coast 2050: Toward a Sustainable Coastal Louisiana. Louisiana Department of Natural Resources. Baton Rouge, La. 161 pp.
- Louisiana Department of Environmental Quality. 1999. Environmental Regulatory Code. Part IX. Water Quality Regulations. 672 pp.
- Martin, R.P., and G.D. Lester. 1990. Atlas and Census of Wading Bird and Seabird Nesting Colonies in Louisiana. Louisiana Department of Wildlife and Fisheries and Louisiana Natural Heritage Program. 182 pp.
- McNease, L., and T. Joanen. 1978. Distribution and relative abundance of the alligator in Louisiana coastal marshes. Proceedings of the Annual Conference of Southeastern Association of Fish and Wildlife Agencies. 32:182-186.
- McNease, L., N. Kinler, T. Joanen, D. Richard, and D. Richard. 1994. Distribution and relative abundance of alligator nests in Louisiana coastal marshes, p. 108-119. In Proceedings of the 12th Working Meeting of the Crocodile Specialist Group of the Species Survival Commission of IUCN - The World Conservation Union convened at Pattaya, Thailand, 2-6 May 1994. IUCN - The World Conservation Union, Rue Mauverney 28, CH-1196. Gland, Switzerland.
- Mid-Continent Oil and Gas Association. 1995. Louisiana Oil and Gas Facts. Louisiana Mid-Continent Oil and Gas Association. Baton Rouge, LA. 20 pp.
- Miller, D. Personal communication. U.S. Department of Agriculture, Natural Resources Conservation Service, Alexandria, LA.

- Moffatt & Nichol Engineers. 2000. Hydraulic Modeling for the Black Bayou Hydraulic and Habitat Restoration Project (CS-27). Prepared for the State of Louisiana Department of Natural Resources. Moffatt & Nichol Engineers, Raleigh, N.C. 90 pp.
- O'Neil, T. 1949. The Muskrat in Louisiana. Louisiana Department of Wild Life and Fisheries. New Orleans, Louisiana.
- Palmisano, A.W. 1973. Habitat preference of waterfowl and fur animals in the northern Gulf Coast marshes, p. 163-190. In R.H. Chabreck (ed.). Proceedings of the coastal marsh and estuary management symposium. Louisiana State University Division of Continuing Education, Baton Rouge La.
- Paul, B. Personal communication. U.S. Department of Agriculture, Natural Resources Conservation Service, Alexandria, LA.
- Penland, S., R. McBride, J.R. Suter, R. Boyd, and S.J. Williams. 1991. Holocene development of shelf-phase Mississippi River delta plains. In Coastal Depositional Systems in the Gulf of Mexico: Quaternary Framework and Environmental Issues, 182-185. Gulf Coast Section, Society of Economic Paleontologists and Mineralogist Foundation, Twelfth Annual Research Conference, Austin Texas.
- Rader, D.N. 1984. Salt-marsh benthic invertebrates: small-scale patterns of distribution and abundance. *Estuaries*. 7:413-420.
- Rogers, B.D., R.F. Shaw, W.H. Herke, and R.H. Blanchet. 1993. Recruitment of postlarval and juvenile brown shrimp (*Penaeus aztecus* Ives) from offshore to estuarine waters of the northwestern Gulf of Mexico. *Estuarine, Coastal and Shelf Science*. 36:377-394.
- Rozas, L.P. 1993. Nekton use of salt marsh of the southeast region of the United States. Coastal Zone '93. Proceedings of the 8th Symposium Coastal Ocean Management. American Society of Civil Engineers. New York.
- Rozas, L.P., and C.T. Hackney. 1984. Use of oligohaline marshes by fishes and macrofaunal crustaceans in North Carolina. *Estuaries*. 7:213-224.
- Stanley, J.G., and M.A. Sellers. 1986. Species Profiles: Life Histories and Environmental Requirements of Coastal Fishes and Invertebrates (Gulf of Mexico)-- American Oyster. U.S. Fish and Wildlife Service Biological Report 82 (11.64). 25 pp.
- Turner, R.E., and M.S. Brody. 1983. Habitat suitability index models: northern Gulf of Mexico brown shrimp and white shrimp. U.S. Department of Interior, Fish and Wildlife Service, FWS/OBS-82/10.54. 24 pp.

- Turner, R.E., and D.R. Cahoon, ed. 1988. Causes of Wetland Loss in the Coastal Central Gulf of Mexico, 2 vol. OCS Study MMS 87-0120. U.S. Department of the Interior, Minerals Management Service, OCS Regional Office, New Orleans.
- U.S. Department of Agriculture. 1977. Gulf Coast Wetlands Handbook. Soil Conservation Service, Alexandria, Louisiana.
- U.S. Department of Agriculture. 1995a. Preauthorization Planning Report Sabine-Black Bayou Watershed Cameron and Calcasieu Parishes, Louisiana. Natural Resources Conservation Service, Alexandria, LA. 16 pp.
- U.S. Department of Agriculture. 1995b. Soil Survey of Cameron Parish, Louisiana. Soil Conservation Service in Cooperation with the Louisiana Agricultural Experiment Station and the Louisiana Soil and Water Conservation Committee. 135 pp. plus maps.
- U.S. Department of Agriculture, Natural Resources Conservation Service. 1997. Final Project Plan and Environmental Assessment for Sweet Lake/Willow Lake, C/S-11b, Cameron Parish, Louisiana. Alexandria: USDA/NRCS. 32 pp. plus appendices.
- U.S. Department of Agriculture, Soil Conservation Service. 1994. Calcasieu-Sabine Cooperative River Basin Study Report. USDA in Cooperation with Gulf Coast Soil and Water Conservation District, U.S. Fish and Wildlife Service, Louisiana Department of Natural Resources, Louisiana Department of Wildlife and Fisheries, and Louisiana Department of Agriculture and Forestry. 151 pp. plus maps and appendices.
- U.S. Department of Commerce. 1999. Fisheries of the United States, 1998. Current Fishery Statistics No. 9800. National Oceanic and Atmospheric Administration, Washington, D.C. 130 pp.
- U.S. Department of Commerce. 1997. Fisheries of the United States, 1996. Current Fishery Statistics No. 9600. National Oceanic and Atmospheric Administration, Washington, D.C. 169 pp.
- U.S. Fish and Wildlife Service. 1999. Endangered and Threatened Species of the Southeastern United States (The Red Book). Prepared by Ecological Services, Division of Endangered Species, Southeast Region, Government Printing Office, Washington, D.C.
- Valentine, J.M., Jr. 1976. Plant succession after saw-grass mortality in southwestern Louisiana. Proceedings of the Annual Conference of Southeastern Association of Fish and Wildlife Agencies 30:634-640.

APPENDIX "B"

AGENCY CONSULTATION LETTERS



**UNITED STATES DEPARTMENT OF COMMERCE
National Oceanic and Atmospheric Administration
NATIONAL MARINE FISHERIES SERVICE**

SOUTHEAST FISHERIES CENTER
LAFAYETTE OFFICE
U.S.L., P.O. BOX 42451
LAFAYETTE, LA 70504

September 22, 2000

Mr. Charles Oravetz
U.S. Department of Commerce
NOAA/NMFS
Southeast Fisheries Science Center
Protected Resources Division
9721 Executive Center Drive, N. (F/Ser3)
St Petersburg, FL 33702

Dear Mr. Oravetz,

Please find enclosed an environmental assessment concerning the Black Bayou Hydrologic Restoration Project (CS-27), proposed by the National Marine Fisheries Service under the Coastal Wetlands Planning, Protection, and Restoration Act.

We would greatly appreciate your review of this document. The Black Bayou project will largely restore the natural hydrology of this area and contribute to the continued existence of this unique system. We would greatly appreciate your review of this document with regard to any possible impacts to endangered species in the region. Please return your comments to my office no later than October 10, 2000.

Sincerely,

John D. Foret
John D. Foret.
Biologist

Enclosure

**THE PROPOSED ACTION IS NOT LIKELY
TO ADVERSELY AFFECT LISTED
ENDANGERED OR THREATENED SPECIES
OR DESIGNATED CRITICAL HABITAT
PROTECTED BY THE ENDANGERED
SPECIES ACT OF 1973, AS AMENDED.**
Eric G. Hawk
**SECTION 7 COORDINATOR
NATIONAL MARINE FISHERIES SERVICE
SOUTHEAST REGIONAL OFFICE
ST. PETERSBURG, FLORIDA
DATE: Oct. 2, 2000**





UNITED STATES DEPARTMENT OF COMMERCE
National Oceanic and Atmospheric Administration
NATIONAL MARINE FISHERIES SERVICE
SOUTHEAST FISHERIES CENTER
LAFAYETTE OFFICE
U.S.L., P.O. BOX 42451
LAFAYETTE, LA 70504

September 22, 2000

Ms. Geri Hobdy
State of Louisiana
Office of the Lieutenant Governor
Office of cultural Development
Division of Archaeology
P.O. Box 44247
Baton Rouge LA 70804-4247

Dear Ms. Hobdy,

Please find enclosed an environmental assessment concerning the Black Bayou Hydrologic Restoration Project (CS-27), proposed by the National Marine Fisheries Service under the Coastal Wetlands Planning, Protection, and Restoration Act.

We would greatly appreciate your review of this document. The Black Bayou project will largely restore the natural hydrology of this area and contribute to the continued existence of this unique system. We would greatly appreciate your review of this document with regard to any possible impacts to cultural resources in the region. Please return your comments to my office no later than October 10, 2000.

Sincerely,

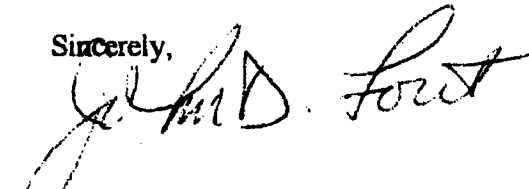

John D. Foret
Biologist

Enclosure

Date: <u>10/20/00</u>
No known archaeological sites or historic properties will be affected by this undertaking. This effect determination could change should new information come to our attention.
Geri Hobdy: <u>Geri Hobdy</u> State Historic Preservation Officer

RECEIVED
OCT 2 2000





United States Department of the Interior



FISH AND WILDLIFE SERVICE

646 Cajundome Blvd.
Suite 400
Lafayette, Louisiana 70506

October 10, 2000

Mr. John Foret
National Marine Fisheries Service
Southeast Fisheries Center
Lafayette Office
U. L. L. Post Office Box 42451
Lafayette, LA 70504

Dear Mr. Foret:

The U.S. Fish and Wildlife Service (Service) has reviewed the draft Environmental Assessment (EA) for the Black Bayou Hydrologic Restoration Project (CS-27), located in Calcasieu and Cameron Parishes, Louisiana. The preferred alternative plan consists of installing 16 miles of vegetative plantings, protecting 33,830 feet along the southern bank of the Gulf Intracoastal Waterway (GIWW), installing rock weirs with barge and/or boat bays in Black Bayou Cutoff Canal, Burton Canal, and in Blocks Creek, and relocating and replacing an existing weir with a weir and self-regulating tide gate east of the Black Bayou Cutoff Canal. The Service submits the following comments in accordance with provisions of the Fish and Wildlife Coordination Act (48 Stat. 401, as amended; 16 U.S.C. 661 et seq.) and the Endangered Species Act of 1973 (87 Stat. 884, as amended; 16 U.S.C. 1531 et seq.).

General Comments

The EA is generally accurate in its assessment of impacts on fish and wildlife resources. The final EA should more fully substantiate the anticipated effects of the project components on salinities within the project area. The project should assist in reducing excessive salinities, as well as reducing shoreline erosion along the GIWW, and may increase vegetated marsh acreage via the vegetative planting component. The EA should be revised to reflect the 1997 habitat mapping information (Chabreck et al. 1997) which indicates that the project area has converted to an intermediate marsh that extends to Sabine Lake, with fresher vegetation located in the eastern portion of the project area. We suggest that the final EA provide documentation of elevated salinities as well as available modeling information predicting how the project would reduce excessive salinities.

Specific Comments

Page 2, paragraph 1 - This paragraph states that the Calcasieu-Sabine Basin contains 312,500 acres of marsh. Page 13 of the EA states that there are 317,100 acres of marsh within the basin. Therefore, paragraph 1 on page 2 should indicate that the 312,500-acre figure is derived from the

U.S. Geological Survey and the Louisiana Department of Natural Resources 1988/1990 habitat maps and statistics as presented in the 1993 Louisiana Coastal Wetlands Restoration Plan (Louisiana Coastal Wetlands Conservation and Restoration Task Force 1993). The 317,100-acre figure is from the Coast 2050 Plan and derived from Corps of Engineers' data (Dunbar et al. 1992).

Page 2, last paragraph - The EA indicates project-area marshes increased nearly 2,000 acres from 1984 to 1990. Elsewhere in the EA, it is stated that there has been marsh loss caused by saltwater intrusion. These statements should be reconciled.

Page 6, paragraph 3 - The first sentence indicates that the area was nearly all brackish marsh in 1988; that sentence should be updated to include the latest 1997 habitat marsh types as delineated by Chabreck et al. (1997). Those maps indicate that the area was intermediate and fresh marsh in 1997. The discussion indicating that the area is brackish marsh with declining habitat quality should be updated in light of that 1997 information.

Page 6, paragraph 5 - The first sentence should be revised to indicate that the project area does not presently consist of brackish marsh.

Page 7, paragraph 5 - The conversion of marsh to open water habitats appears to have occurred prior to 1984. In addition, the area has experienced a recent shift from brackish to intermediate marshes. Therefore, the rate of conversion from marsh to open water under the without-project scenario may be reduced.

Page 9, paragraph 2 - This paragraph should include additional discussion of specific model results.

Page 9, paragraph 3 and bullets - The bullets should include more details regarding model results as they relate to specific structure components.

Page 9, paragraph 3 - The first bullet provides specifics that support the model conclusion that the culverts are unnecessary. The second bullet, however, discusses the recommended structure (a self-regulating tide gate weir) without discussion any of the model specifics regarding that structure. That bullet should include model specific conclusions regarding structure benefits.

Page 10, 1st bullet - It is unclear why the large rock structures with boat and barge bays are included as project components; the model indicated that they would cause minimal dampening of the tidal range and have a small positive effect on reducing salinities.

Page 10, paragraph 2 - The project components will have to effectively reduce salinities if the proposed bullwhip plantings west of the Black Bayou Cutoff Canal are to survive. We suggest that the EA note whether the model predicts that salinities would be reduced sufficiently to allow survival of the bullwhip plantings.

Page 12, paragraph 5 - The correct name for the "Sabine Migratory Waterfowl Refuge" is the

Sabine National Wildlife Refuge.

Page 12, paragraph 6 - This paragraph indicates that the 1990 loss rate is 5.36 square miles per year; the reference for that information should be included. Barras et al. (1994) lists a Calcasieu-Sabine basin loss rate of 2.6 square miles per year (between 1978 and 1990). The Louisiana Coastal Wetlands Restoration Plan projects a loss rate of 1.71 square miles per year for the period 1990 to 2010 (Louisiana Coastal Wetlands Conservation and Restoration Task Force 1993).

Page 13, paragraph 1, sentence 6 - This sentence should be revised to indicate that the 50,840 acres of marsh would be lost within the Calcasieu-Sabine Basin by the year 2050 (Louisiana Coastal Wetlands Conservation and Restoration Task Force and the Wetlands Conservation and Restoration Authority 1998).

Page 14, paragraph 1 - Sentences 2 and 3 discuss salinity in the project area in very general terms. It would be more descriptive, and may better document project need, if summary data or a figure could be included depicting mean annual or monthly salinities. The Service can provide you with salinity data from our seven discrete salinity stations located in the Black Bayou area; those data are collected bimonthly by the Sabine National Wildlife Refuge staff. The fourth sentence discusses the brackish marsh salinity range. Since the area is now mostly or wholly intermediate and fresh marsh, it would be pertinent to include a sentence about intermediate marsh salinity ranges.

The Galveston District, Corps of Engineers, is presently conducting a feasibility study addressing the possible deepening and widening of the Sabine-Neches Waterway, located along the western portion of Sabine Lake. Such channel deepening has the potential for increasing salinities in Sabine Lake and Black Bayou.

Page 14, paragraph 2, second-to-last sentence - This sentence should be revised to include the 1997 habitat types for the project area contained in Chabreck et al. (1997). See the above discussion regarding Protection of Wildlife Habitat (EA page 6).

Page 18, paragraph 3 - Sentence 4 states that no bald eagle nests have been found in southwestern Louisiana. According to our database, an active bald eagle nest is located in Calcasieu Parish approximately 8 miles north of the center of the project area. Wintering eagles have been sighted in Cameron Parish at the Lacassine National Wildlife Refuge and near Sweet Lake. The referenced sentence should be revised to reflect the above information.

Page 21, paragraph 1 - The 1993 Louisiana Coastal Wetlands Restoration Plan states that the Calcasieu-Sabine Basin contains 630,000 acres, consisting of all habitats (land and water). The source for the different acreage information used in the referenced paragraph should be identified.

Page 21, last paragraph - This section (or a previous section) should clearly indicate specific model findings regarding project component effectiveness.

Page 22, paragraph 1 - Sentence 2 (first full sentence) should indicate to what degree the barge bay and two boat bay structures will reduce salinities.

Page 22, paragraph 1 - It is unclear, in the penultimate sentence, that the project-area wetlands would continue to convert to open water; there may have been a gain in marsh during the period 1984 to 1990 according to available satellite data.

Page 23, last paragraph - We suggest that the first sentence be revised to indicate that, although bald eagles have been recorded as nesting in Calcasieu Parish and have been observed in Cameron Parish, no adverse project impacts are anticipated. The Service concurs that the proposed action is not anticipated to have significant adverse impacts on endangered or threatened species.

Page 25, first paragraph - The second sentence mentions site-specific data, yet few such data are presented in the EA.

Summary Comments

The Service concurs with the EA that the preferred plan will have benefits to fresh, intermediate and brackish marshes by reducing excessive salinities, especially during storm events. We strongly support implementation of the preferred plan.

Thank you for the opportunity to provide comments on the above-referenced EA. If your staff has any questions regarding our comments, please have them contact Darryl Clark (337/291-3111).

Sincerely,



David W. Frugé
Field Supervisor

cc: NMFS, Baton Rouge, LA
EPA, Baton Rouge, LA
NRCS, Alexandria, LA
LA Department of Wildlife and Fisheries, Baton Rouge, LA
LA Department of Natural Resources (CRD), Baton Rouge, LA
LA Department of Natural Resources (CRD), Abbeville, LA
LA Department of Natural Resources (CMD), Baton Rouge, LA

REFERENCES

- Barras, J. A., P. E. Bourgeois, and L. R. Handley. 1994. Land loss in coastal Louisiana 1956-90. National Biological Survey, National Wetlands Research Center, Open File Report 94-01.
- Chabreck, R.,H., G. Linscombe, S. Hartley, J. Johnston, and A. Martucci. 1997. Louisiana Coastal Marsh Vegetative Type GIS CD. Louisiana Department of Wildlife and Fisheries, New Orleans, Louisiana, USGS, National Wetlands Research Center, Lafayette, LA.
- Louisiana Coastal Wetlands Conservation and Restoration Task Force. 1993. Louisiana Coastal Wetlands Restoration Plan. Calcasieu/Sabine Basin. Appendix 1. 236 pp.
- Louisiana Coastal Wetlands Conservation and Restoration Task Force and the Wetlands Conservation and Restoration Authority. 1998. Coast 2050: Toward a Sustainable Coastal Louisiana. Louisiana Department of Natural Resources. Baton Rouge, LA. 161 pp.



**UNITED STATES DEPARTMENT OF COMMERCE
National Oceanic and Atmospheric Administration**

NATIONAL MARINE FISHERIES SERVICE
Southeast Regional Office

9721 Executive Center Drive North
St. Petersburg, Florida 33702

October 10, 2000 F/SER44/RH:jk
225/389-0508

Mr. John Foret
National Marine Fisheries Service
Department of Biology
Post Office Box 42451
Lafayette Louisiana 70504-2451

Dear Mr. Foret:

The Baton Rouge office of the National Marine Fisheries Service (NMFS) has received the draft Environmental Assessment (EA) for the Black Bayou Hydrologic Restoration Project (CS-27) provided by your letter of September 22, 2000. That document evaluates the impacts of implementing structural measures to restore the wetland hydrology of the Black Bayou area in northwestern Cameron Parish, Louisiana. This project is funded under the auspices of the Coastal Wetlands Planning, Protection and Restoration Act with the NMFS as the Federal sponsor.

In response to the requirements of the Magnuson-Stevens Fishery Conservation and Management Act (Magnuson-Stevens Act) and its implementing regulations, the EA incorporates an assessment of project construction and implementation impacts on Essential Fish Habitat (EFH). The document adequately discusses impacts to those Federally-managed fisheries for which EFH has been identified. We find, however, that it fails to fully incorporate all of the required components of an EFH assessment as specified at 50 CFR 600.920(g)(2). Following are recommended revisions to the final EA which we believe are necessary to incorporate all the components of an EFH assessment.

- Either the EA introduction or cover letter should clearly state that the document incorporates an EFH assessment and is intended to initiate consultation required by the Magnuson-Stevens Act.
- Section 4.2.2 of the EA should be expanded to specify the habitat types which: 1) would be affected by the project; and, 2) provide EFH for the Federally-managed species which commonly occur in the Black Bayou watershed. For the species you have identified, the Gulf of Mexico Fishery Management Council has determined EFH to be: brown shrimp postlarvae/juveniles - marsh edge, submerged aquatic vegetation, tidal creeks, and inner marsh; brown shrimp subadults - mud bottoms and marsh edge; white shrimp postlarvae/juveniles/subadult - marsh edge, submerged aquatic vegetation, marsh ponds, inner marsh, and oyster reefs; red drum postlarvae/juvenile - submerged aquatic



vegetation, mud bottom, marsh edge; and red drum subadult/adult - mud bottom and oyster reef.

- Section 5.2.2 should quantify and discuss the magnitude of adverse impacts to each category of EFH (for instance, it appears from the figures attached to the EA that nearly 0.5 acre of EFH of the marsh-edge type would be destroyed by fill placement). This discussion also should contrast habitat losses with the gains and enhancements to EFH once the project is operational.
- The conclusions presented in section 6.0 should include a statement of NMFS' views on the project impacts to EFH.

The identified EFH assessment needs should be rectified in the final EA and be used as a template for future CWPPRA EAs prepared by your office. However, please be advised that based on our review of the information provided for this project, we have no EFH Conservation Recommendations to offer.

We appreciate the opportunity to review and comment on the draft EA and unsigned FONSI. If you wish to discuss this project further or have questions concerning our recommendations, please contact Richard Hartman at 225-389-0508.

Sincerely,



for Andreas Mager, Jr.
Assistant Regional Administrator
Habitat Conservation Division